



designed to be different



CELEBRATING WARMTH

GAS FIRES 2018/2019







designed to be different

THE PERFECT INTERPLAY BETWEEN STYLE, FUNCTION AND RELIABILITY

With every fire that we design, we try to imagine what role it will play in the lives of our customers. Every detail contributes to an ideal experience of warmth, atmosphere and comfort. During development, we leave nothing to chance so that our customers can fully enjoy their fire. Form and function blend seamlessly to create a DRU fire.

PRODUCTS WITH VALUE

Passion leads to amazing results: DRU has demonstrated this for more than 260 years. Our rich experience and continuity is what inspires us to look ahead. We always look for better, cleaner and smarter solutions. This results in innovative fires that are unique in the market and increase the ease of use and comfort for our customers. We safeguard our high quality by imposing very strict requirements on all our products and services. In our designs, we strive towards the most achievable performance with the lowest emissions and the optimum combination of style, function and reliability.



DRU HELPS YOU CHOOSE

Thinking of buying a gas fire? Choosing a gas fire needs a systematic approach, depending on your living space, your wishes and expectations. DRU helps you by posing the right questions and mapping the possibilities based on the list at the left-hand side. What is the purpose of a fire in your home? Simply heat or mainly decoration and cosiness? How big is the area that you want to heat? Which designs and styles best fit the interior of your home? That way, you make a well-considered decision about which gas fire meets your wishes. Our innovations ensure that you'll shortly enjoy your new fire without any worries.

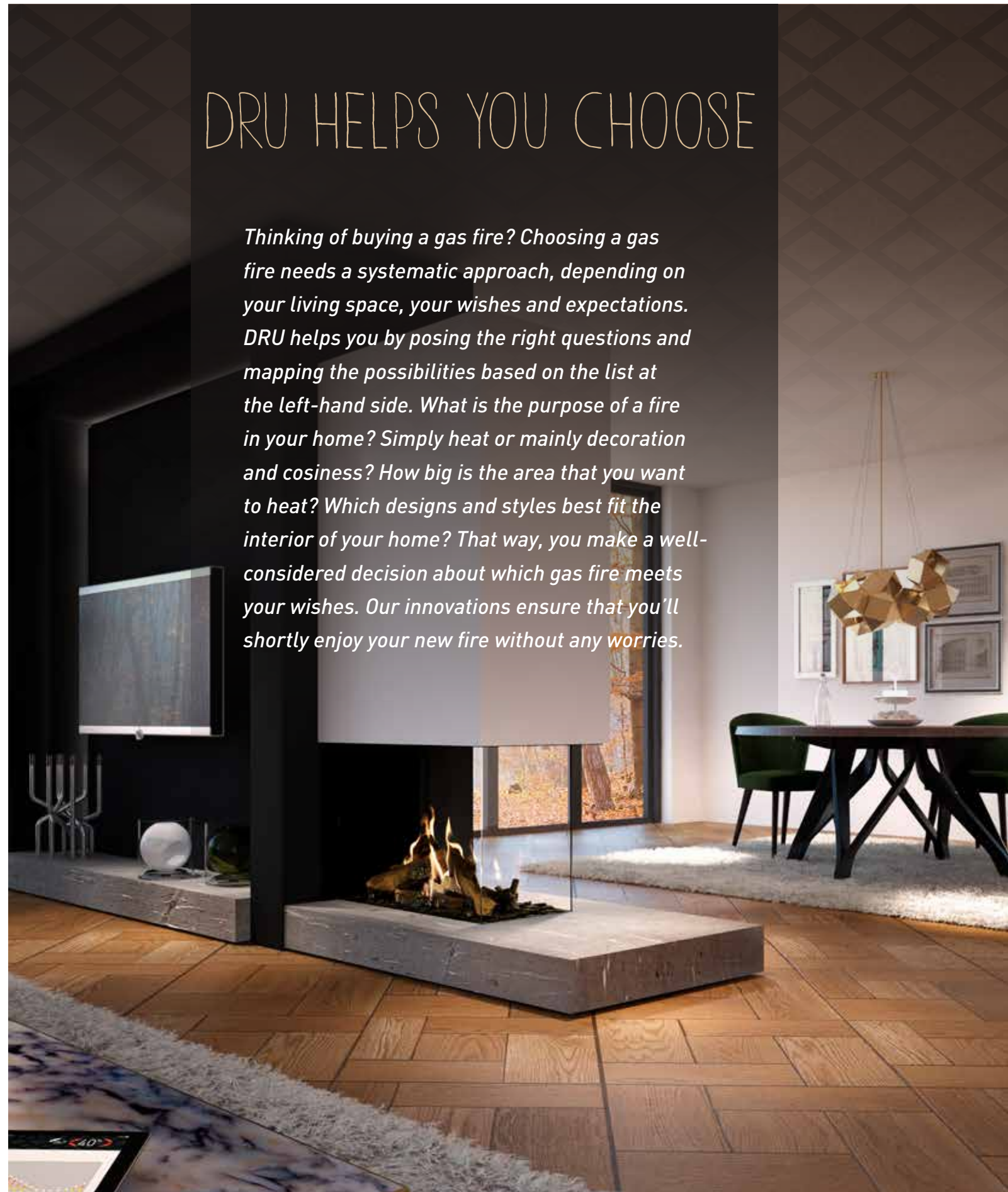

TABLE OF CONTENTS

Choose the fire that suits you best

The perfect combination of warmth and atmosphere.

6

Easy to clean with an easy to open door.

14

The loveliest flame pattern.

8

Make your fire more personal by choosing an individual frame.

16

A beautiful fire bed: glass, stones or wood.

10

An existing flue or extraction via the wall, ceiling or crawl space.

18

Choose the interior finish that matches your fire.

12

Energy efficiency class and types of gas.

20

Anti-reflective glass window.

13

Supply and extraction of oxygen and flue gasses.

20



DRU FIRES PRODUCT RANGE 22

• DRU 3-sided fires	24
• DRU 2-sided fires	36
• DRU Front fires	43
• DRU Tunnel fires	54
• DRU Freestanding fires	62

DRU HELPS YOU CHOOSE; CONTENTS

• Attachments and accessories	86
• Where to buy	88
• Technical drawings	90
• Technical specifications	96

GLOBAL FIRES COLLECTION 68

Open combustion (CF)

• Global Front fires	70
• Global Freestanding fires	74

Closed combustion (BF)

• Global 3-sided fires	75
• Global 2-sided fires	78
• Global Front fires	80

OUTPUT

*Correct control of the heat output
and always a perfect flame picture.*



ATMOSPHERE AND WARMTH WITH ECO WAVE

A spacious designer-fire is a beautiful acquisition for your home. However, its output must match the space in which you place the fire. Large fires heat small areas rapidly, forcing you to quickly lower the heat. This is usually at the expense of a nice flame pattern. Eco Wave makes this situation a thing of the past.

The unique features of Eco Wave (exclusive to DRU) are:

- Controllable heat output, continuously adjustable
- Adjustable flame pattern
- High flames with low gas consumption
- App for operation via smartphone or tablet

DRU Eco Wave gas fires provide an attractive flame pattern, even at a lower heat setting. The Eco Wave system ensures natural flame motion, even when you reduce the output. In addition to being beautiful and easy to operate, Eco Wave is also very economical.

Control from experience

You can set the flame pattern at the desired heat setting using the smart remote control, which also functions as a thermostat. With the free DRU control app on your smartphone or tablet (IOS and Android), you have even more control of your fire. In addition to the standard operating functions, you can also use this app to select your favourite flame pattern.

Do you want full control and constant lively flames? Then choose a fire equipped with the unique DRU ECO WAVE technology. The output range is the scope of the output from its lowest to highest setting. This may vary per gas type.

What kind of fireplace is best for my home?

When choosing a stove or fireplace, the unit's capacity is a determining factor. Many do not realize that only 6 kilowatts (kW) will be enough to heat an average living room (60 m³). Thanks to the large output range of the DRU Eco Wave fireplaces, they are ideal for atmosphere and warmth.

Your home is:

- A** ▶ Well insulated
 - ▶ Equipped with double-glazing and insulation of walls and floors
- B** ▶ Reasonably insulated
 - ▶ With a minimum double glazing and a minimum insulation of walls and floors
- C** ▶ Poorly insulated
 - ▶ No double glazing

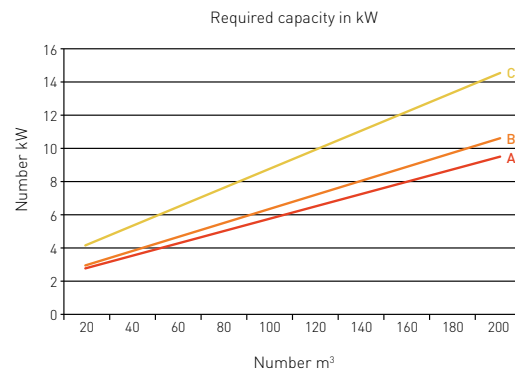



layar

Scan this page
with the Layar app.

NOT TOO HOT
AND STILL
LIVELY FLAMES

- Total control over flame picture and heat output
- Up to 50% savings in gas consumption
- Easy control via smartphone or tablet



Brochure with burning fire

Would you like to experience the ambience created by a DRU gas fire? Then simply scan the pages where you see this logo. The Layar app allows you to see the fire burning with real flames. The Layar app is free to download and can be used on all tablets (iPad and Android) and smartphones (iPhone and Android).

layar

FLAME PATTERN

With our unique burner technology, we offer you a flame pattern that best suits your taste.

CREATE A PERSONAL FLAME PATTERN



Dynamic Flame Burner®



Vario Burner



Line Burner



Global Truflame Burner®

With our unique burner technology, you choose the flame pattern that suits your taste.

Are you looking for the experience of realistic fire, as well as the feel of a designer-fireplace? DRU and Global gas fires stand out due to their unique burners that can create multiple flame patterns.

- Lively, natural flames with the Dynamic Flame Burner®
- Wide and deep fire with the Vario Burner
- Straight, horizontal fire with high flames with the Line Burner
- Perfect log flame effect with the Global Truflame Burner®

Identical to real fires

DRU uses other methods to give a sense of a real wood fire.

Applying glowing embers gives the effect of glowing charcoal in a wood fire.

The wood logs are produced to look real, come in a wide range of colours and wood types and are assembled naturally. Our focus on details guarantees you the best possible experience

DYNAMIC FLAME BURNER®

*With the Dynamic Flame Burner®,
DRU achieves a copy of a real wood fire.*



Looking to experience a real wood fire with the advantages of a gas fire? The Dynamic Flame Burner® makes it possible. This unique burner was especially developed by DRU and combines the ease of gas with the unique experience of a real wood fire. The system consists of two elements: the first burner in the fire bed creates a wide and deep fire; the second burner, which can be switched off, provides volume and height. This burner is built into ceramic wood logs, causing the flames to lap around them.

VARIO BURNER

A wide and deep fire with the Vario Burner.



Looking for a rich flame pattern with lots of perspective? We create the illusion of a real wood fire by using wide and high flames, but also by providing depth to the fire. The Vario Burner, developed by DRU, gives the fire multiple dimensions with a unique zigzag design. Moreover, with the DRU Eco Wave technology, you retain a beautiful flame pattern over the entire width of the fire, even at a lower heat setting.

FIRE BED

Choose your favourite fire bed.

DRU offers the following options:

- Log set in brown or birch white:
The structure and colour makes it indistinguishable from the real thing.
- Anthracite glass: the reflection of the fire provides additional depth
- Stones: white and grey



Brown log set



White log set

LINE BURNER

The Line Burner creates high flames in a lovely tight line.



Would you rather see high flames in a straight line across the width of the fire? Many DRU gas fires are equipped with a line burner. This burner gives you a unique, dynamic flame pattern in a tight, horizontal line, which makes the fire an eye-catching element in your home.

Available for a part of the range of products



Anthracite glass



White stones



Grey stones

GLOBAL TRUFLAME BURNER®

Perfect flame effect with the Global Truflame Burner®.



For a high and natural log fire choose the Global Truflame Burner®. The burners are placed at an upward angle and integrated in the ceramic wood logs, causing the flames to lap around the logs. It almost feels like a real wood fire. This beautiful flame is available in several gas fires from the Global range.

INTERIORS

Plenty of options for the interior finish of your fire.

DRU offers you a number of options for the interior finish of your fire:

- Classic stone: for a classical or country-style look, looks like the old masonry open fires
- Black: modern design and ideal with Clear View glass
- Ceraglass: a nice reflecting effect that creates extra depth in your fire
- Natural: light-yellow wall equipped with fine profiles

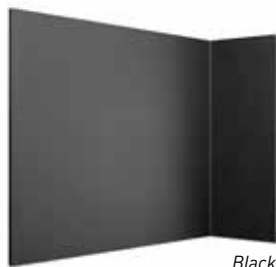

Black

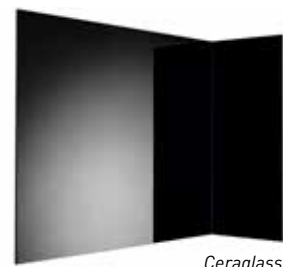

Ceraglass

CLEAR VIEW GLASS

Always optimal view of the fire with Clear View glass.



NATURALLY TRANSPARENT



The true pleasure of a fire is when you can see the flames clearly. When we developed Clear View glass, we got our inspiration from the open fireplaces of long ago. DRU Clear View glass is developed in such a way that it looks as if there is no glass at all. You enjoy the comfort of a gas fire with the mirage of a real wood fire.

Available for nearly all the DRU models.

Available for a part of the range of products



Natural



Classic stone (DRU)



Classic stone (Global)

EASY RELEASE DOOR SYSTEM

The easy release door system is a special spring-loaded or swing door that allows easy cleaning and maintenance of your fire.



EASY ACCESS

A gas fire gives you warmth and atmosphere in your home with a push of a button. You therefore enjoy using it every day. Gas fires do not demand excessive maintenance, but cleaning and maintaining at fixed times is important. The burner should be maintained once a year by a fitter while cleaning the glass is a task you can do yourself. Opening the fire for maintenance and cleaning is actually very easy, if you have the unique DRU Easy release door system. This spring-loaded or swing door can be opened easily and effortlessly. No need for screwing or heavy lifting.

Superb design

With the patented Easy release door system of DRU, it is very simple to open the door of your fire using a subtly concealed handle. The frames of the 2-sided and 3-sided models can be fully hidden from view, creating more glass surface. That always gives you an unobstructed view of the lovely flames. Moreover, in the 2-sided and 3-sided models, we have used seamless glass on glass. That makes the fire fully air tight, ensuring optimal burning and safety.



Front and tunnel fires



2- sided and 3- sided fires (see page 29, 37)



layar

Scan this page
with the Layar app.

EXAMINE HOW THIS UNIQUE INNOVATION WORKS

- *Handy spring-loaded or swing door*
- *Subtle concealed handle*
- *Frameless (in the 2-sided or 3-sided versions)*
- *No need for screwing or heavy lifting*

FRAMELESS AND
MODERN FINISH



STANDARD, FRAMELESS OR CUSTOMISED

Choose from a range of frames for your new fire.

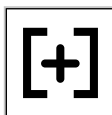

FRAMED

Standard frames or frameless

All DRU fires are supplied with a frame as standard. Do you prefer to integrate the fire seamlessly into your living space? With certain fires, it is possible to remove the lower part of the frame. That makes it possible to build the fire into a natural stone plateau or to sink the glass window directly into the floor.

Customisation possible

You can personalise your fire further. In the 2-sided and 3-sided built-in fires below, DRU offers the option of frames in various widths. They are available in a width of 100 mm, but can also be custom-made in widths between 90/100 and 200 mm. In the overview below, you can see in which fires this option is possible.



Frameless, bottom frame can be removed



Standard frame



Optional frame (customisation possible)

Fires that can be built in without a frame

3-Sided fires	2-Sided fires	Front fires	Tunnel fires
Maestro 75XTU	Maestro 80/2	Maestro 75	Maestro 75 Tunnel
Maestro 80/3	Maestro 105/2	Maestro 100	Metro 200XT Tunnel
Maestro 105/3	Metro 100XT/2	Metro 200XT	Cosmo Tunnel
Metro 100XT/3	Metro 130XT/2	Cosmo	
Metro 100XTL	Lugo 70/2		
Metro 100XTU	Lugo 80/2		
Metro 130XT/3			
Lugo 70/3			
Lugo 80/3			

Optional frames

3-Sided fires	2-Sided fires
Maestro 75XTU	Maestro 80/2
Maestro 80/3	Maestro 105/2
Maestro 105/3	Metro 100XT/2
Metro 100XT/3	Metro 130XT/2
Metro 100XTL	Lugo 70/2
Metro 100XTU	Lugo 80/2
Metro 130XT/3	
Lugo 70/3	
Lugo 80/3	

Customisation possible 90 mm - 200 mm
(except Maestro 75XTU: 100 mm - 200 mm)

INSTALLATION OPTIONS

You are free to place your fire wherever you want.



NO CHIMNEY AND YET THE POSSIBILITY TO INSTALL A LOVELY GAS FIRE?

You can install a gas fire exactly where you want it to be. Connecting it to an existing chimney or installing it next to an outside wall (no chimney) is usually very simple. However, DRU also offers solutions for different and more complex situations. With DRU's PowerVent® technology, the possibilities are nearly limitless; imagine for example positioning your fire in the middle of the room, in your apartment, in a restaurant, hotel or in a showroom. The patented PowerVent® innovation makes it possible to flue through a crawl space, to bridge lengths of up to

100 metres or to flue through various pipe bends. DRU PowerVent® gives you the freedom find solutions.

Advantages of DRU PowerVent®

- Complete freedom of installation
- Ideal for mid-terraced houses, apartments, restaurants, hotels, shops and farms
- Extraction lengths up to 100 metres
- Flueing possible through a crawl space
- Flueing through various pipe bends

No need
for a chimney



Via the roof (flat)

- direct or with the pipe bends

Existing chimneys



Via the roof
 • flexible pipe in the chimney

PowerVent® solutions

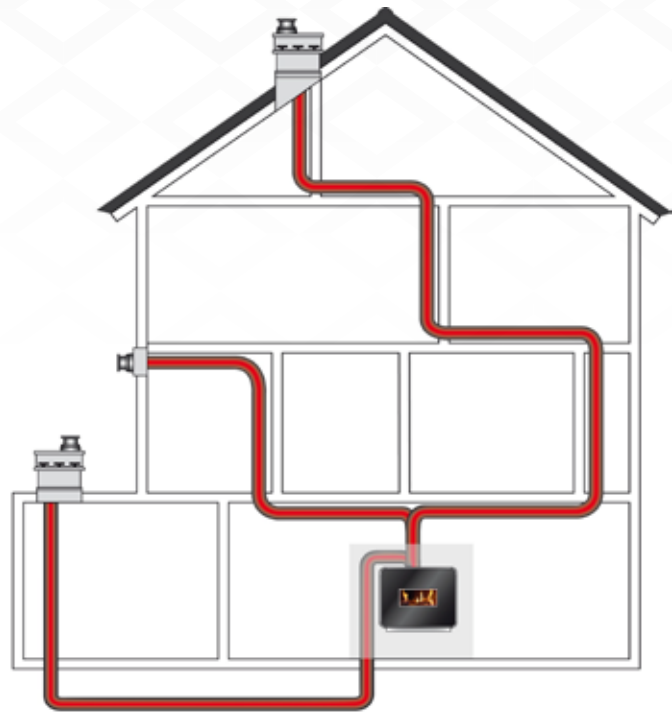

Via the roof, outside wall or crawl space
 • forced extraction using a fan



Via the roof (inclined)
 • direct or with the pipe bends



Via an outer wall
 • directly on the fire via a 90° pipe bend to the outside
 • available for a large part of the product range



Via the outer wall
 • first metre is vertical, followed by a 90° pipe bend

ENERGY EFFICIENCY CLASS

Based on gas type G20.

WHAT DOES AN ENERGY LABEL MEAN FOR YOU?

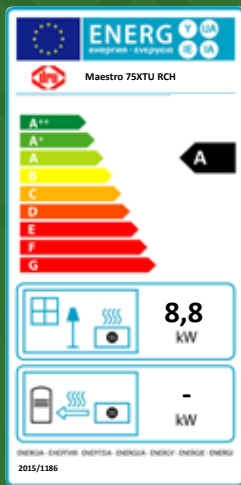

In addition to the energy label, we also use an energy sticker or energy efficiency class. The energy label tells you something about the energy consumption of the device to which the sticker is attached. It is important how efficiently the device consumes energy. After all, the more efficient the fire, the lower your energy consumption. The energy class is based on the product's efficiency; this is also the output listed in the brochure. The output expresses the difference between the energy consumed and the capacity delivered by the fire or stove.

COMBUSTION SYSTEMS

The gas fires are available with open combustion or closed combustion.

All gas fires have closed (BF) or open combustion (CF). An open combustion system uses an existing chimney or flue, with the necessary oxygen being taken from the room in which the fire is located. This is often the more beneficial and simple solution. In contrast, a closed combustion system takes the oxygen directly

from outdoors. A flue is not necessary as supply and extraction can be easily achieved through an outer wall or the roof. Is your residence well-insulated and uses mechanical ventilation? Then a gas fire with closed combustion is almost always the best option.

TYPES OF GAS

DRU fires are suitable for various types of gas.

FIRES PREPARED FOR VARIOUS TYPES OF GAS

Biogas, green gas and gas from overseas have become increasingly common. That is why DRU has prepared its entire product range for the changing nature of gas. Each type of gas creates a different flame pattern. By taking this into account, we make sure that in the future you can continue to enjoy a lovely and attractive gas fire.

No connection to a gas network, but you would like to have an attractive gas fire?

Do you live in a remote area or is your residence heated only by district heating? DRU has the solution. Nearly all our fires are suitable for propane gas, so in most cases it is still possible to install a DRU gas fire.



If you see this logo on a fire, then you know that it is equipped with a Safety Control System (Dutch: VBS). The specific fire is then suitable for using various types of gasses.

CF

Open combustion

- Supply of oxygen from the living space
- Extraction of flue gasses via a single pipe
- Can be connected to an existing flue



BF

Closed combustion

- Supply of oxygen from outside
- Exhaust of flue gasses via an outside wall or roof
- Supply and extraction via a double-walled pipe
- Preferable in well-insulated houses with mechanical ventilation





Eco Wave [p.06]

Eco Wave gives you total control over the heat output while retaining a lovely flame pattern of your choice.

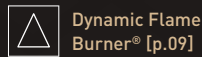

Dynamic Flame Burner® [p.09]

Dynamic Flame Burner® gives you the feeling of a natural wood fire, but with the convenience of gas.



Vario Burner [p.10]

The Vario Burner provides depth and width to the flames of your fire.

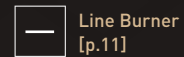

Line Burner [p.11]

The Line Burner provides a lovely tight flame pattern over the width of the fire.

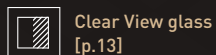

Clear View glass [p.13]

No bothersome reflections; always a clear view of the fire.

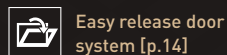

Easy release door system [p.14]

The Easy release door system is a unique spring-loaded or swing door that lets you easily clean and maintain your fire.



Frames [p.16]

Frameless installation or optional frames (customisation possible).



PowerVent® [p.18]

PowerVent® gives you the freedom to install an attractive gas fire regardless of the available space.



Direct flue [p.19]

Directly on the fire via a 90° pipe bend to the outside.

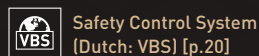

Safety Control System [Dutch: VBS] [p.20]

These fires are completely suitable for various types of gasses and fully prepared for the future.



App Control [p.86]

All DRU Eco Wave fireplaces can be operated via smartphone or tablet with the free DRU Control App (IOS or Android).

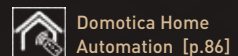

Domotica Home Automation [p.86]

Possibility to connect to home automation systems for smart control in the home.



designed to be different

THE DRU PRODUCT RANGE

Fantastic quality and plenty of choice.

DRU fires offer a perfect solution for every situation and every type of home interior.

All the fires in our large product range meet the strictest requirements in quality, performance, durability and convenience.

From the perspective of design and innovation, the DRU product range is unique.

In the DRU gas fire collection you can select front fires with one glass window, 2-sided and 3-sided fires for a view of the flames from various angles and tunnel fires with glass on two sides. This enables you to have two rooms that are connected by a wonderful focal point. Which type of fire is best suited for you?



3-Sided fires
[p.28]



3-Sided fires XTL
[p.34]



3-Sided fires XTU
[p.24]



2-Sided fires
[p.36]



Front fires
[p.43]



Tunnel fires
[p.54]



Freestanding fires
[p.62]



MAESTRO 75XTU ECO WAVE

Stylish and versatile gas fire.



The Maestro 75XTU with a view of the fire on 3 sides allows you to enjoy the pleasant atmosphere and warmth from several areas. Very suitable for placing in a corner, for example in an L-shaped living room.

Characteristics:

- High windows, a lovely large view of the fire
- Wide output range
- Can be built in tightly and without a frame
- Custom-made frame available

Choose your own size:

(For precise dimensions, see p.90)



75XTU

Maestro 75XTU Eco Wave

A

Output range

Natural gas G20 **1.2 - 8.8 kW**
 Natural gas G25.3 **1.2 - 8.4 kW**
 Propange G31 **1.9 - 9.5 kW**

Efficiency

93.3%

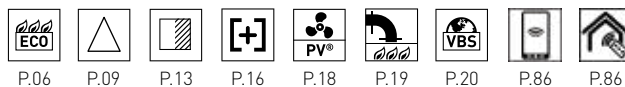

P.06

P.09

P.13

P.16

P.18

P.19

P.20

P.86

P.86



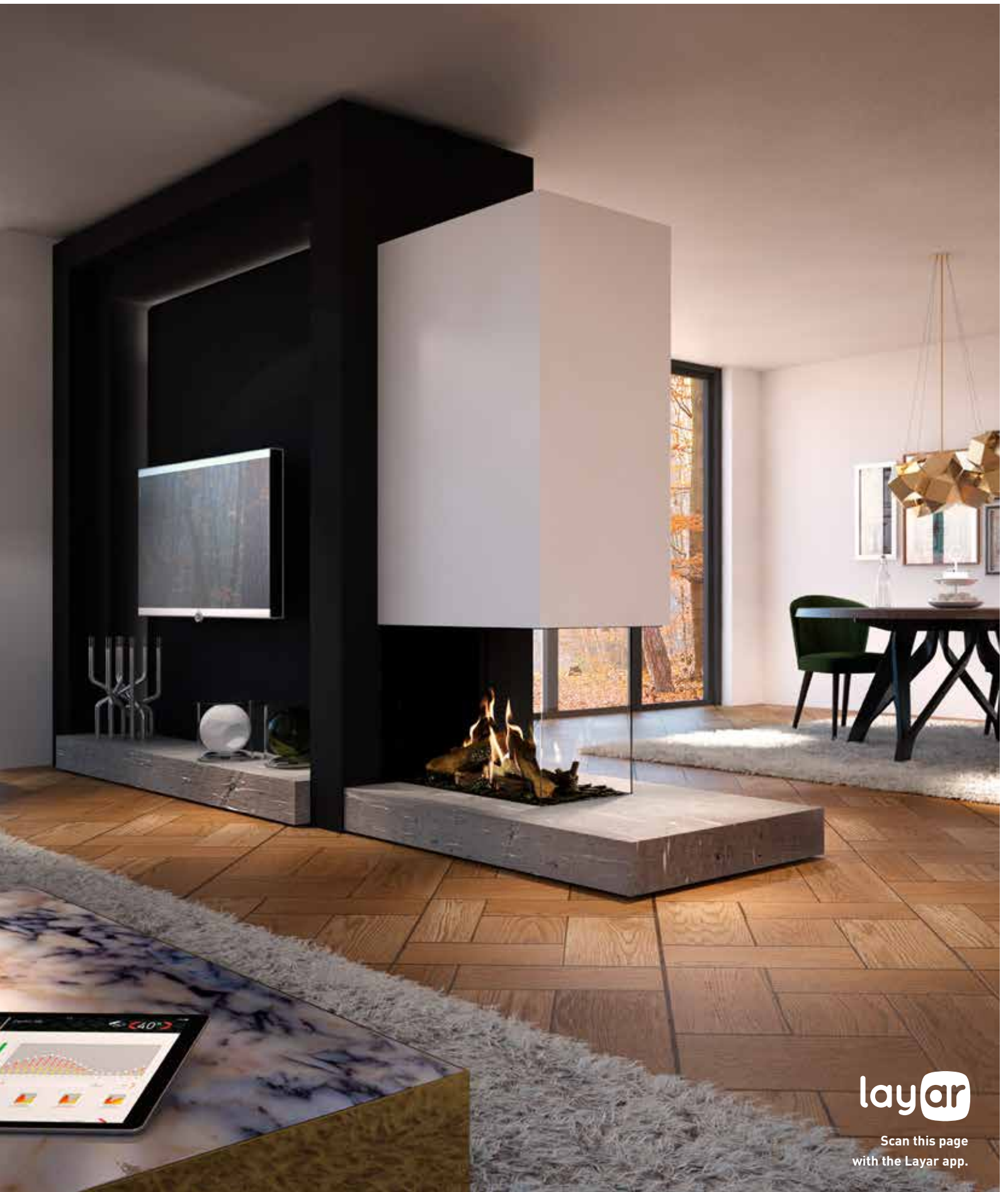

layar

Scan this page
with the Layar app.

METRO 100XTU ECO WAVE

Beautiful room divider gas fire.

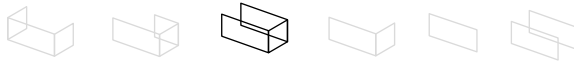

The Metro 100XTU is the ideal fire if you are looking for a room divider or a fire that allows you to enjoy the flames from several corners of your living space.

Characteristics:

- Suitable for installation in a corner
- Also suited for partially suspended or semi-high built in
- Various interior finishes available
- Various fire beds available

Choose your own size:

(For precise dimensions, see p.90)



100XTU

Maestro 100XTU Eco Wave

B

Output range

Natural gas G20 **4.3 - 9.6 kW**
Natural gas G25.3 **3.3 - 9.0 kW**
Propane G31 **4.1 - 9.1 kW**

Efficiency

83.3%

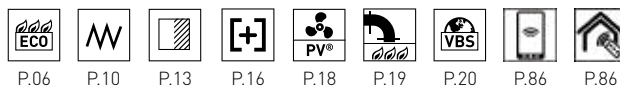



layar

Scan this page
with the Layar app.

MAESTRO 80/3 ECO WAVE

The ultimate 3-sided fire.



Because the Dynamic Flame Burner® is incorporated into wood logs that are indistinguishable from the real ones, the flames surround the wood logs just like in a real fire.

Characteristics:

- 3 high windows
- Optional Clear View glass
- Can be built in without a frame
- Wide output range
- Very high efficiency

Choose your own size:

(For precise dimensions, see p.90)

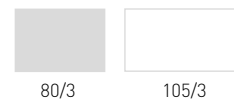

Maestro 80/3 Eco Wave

A

Output range

Natural gas G20 **1.4 - 9.0 kW**
Natural gas G25.3 **1.3 - 8.6 kW**
Propane G31 **1.3 - 7.7 kW**

Efficiency

93.0%

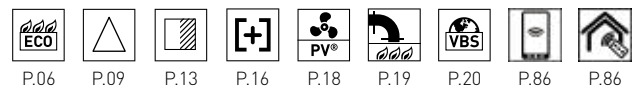

MAESTRO 105/3 ECO WAVE

Award-winning gas fire.



This DRU Eco Wave innovation in the Maestro fires contributes significantly to the "ultimate fire" because the height of the flames can fluctuate from high to low. Natural and lively, just like a real wood fire.

Characteristics:

- Full flames even at a low setting of the fire
- The unique easy release door system
- Can be built in tightly and without a frame

Choose your own size:

(For precise dimensions, see p.90)



80/3



105/3

Maestro 105/3 Eco Wave

Output range

Natural gas G20 **2.2 - 9.3 kW**

Natural gas G25.3 **1.8 - 8.7 kW**

Propane G31 **1.5 - 9.6 kW**

Efficiency

87.5%

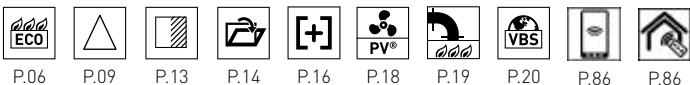

METRO 100XT/3 - 130XT/3 ECO WAVE

Stunning and versatile gas fires.



Metro 100XT/3 Eco Wave

Metro 100XT/3 and 130XT/3 are ideal fires if you want to combine a wide and attractive fire with a view of the fire from several sides.

Characteristics:

- Wide and deep fire
- Suitable for integrating into a cupboard
- Various interior finishes and fire beds

Choose your own size:

(For precise dimensions, see p.90)



100XT/3

130XT/3

Metro 100XT/3 Eco Wave

B

Output range

Natural gas G20 **4.3 - 9.6 kW**
 Natural gas G25.3 **3.3 - 9.0 kW**
 Propane G31 **4.1 - 9.1 kW**

Efficiency

83.3%

Metro 130XT/3 Eco Wave

A

Output range

Natural gas G20 **5.1 - 10.8 kW**
 Natural gas G25.3 **4.1 - 10.2 kW**
 Propane G31 **5.6 - 10.6 kW**

Efficiency

89.6%

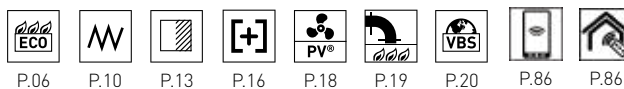

P.06

P.10

P.13

P.16

P.18

P.19

P.20

P.86

P.86

100XT/3
ONLY



Metro 130XT/3 Eco Wave



layar

Scan this page
with the Layar app.

LUGO 70/3 - 80/3 ECO WAVE

Beautiful panoramic fires.



Atmosphere and controllable heat output define the character of these fires with their 3-sided view of the flames. They are suitable for both large and small areas.

Characteristics

- Bottom frame can be removed for a tighter fit
- Lovely flame pattern with low output
- Complete freedom of installation with PowerVent®

Choose your own size:

(For precise dimensions, see p.90)

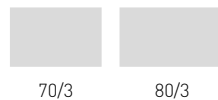

Lugo 70/3 Eco Wave



Output range	Efficiency
Natural gas G20 3.4 - 6.9 kW	91.0%
Natural gas G25.3 2.8 - 6.5 kW	
Propane G31 3.2 - 6.3 kW	

Lugo 80/3 Eco Wave



Output range	Efficiency
Natural gas G20 3.4 - 6.9 kW	91.0%
Natural gas G25.3 2.8 - 6.5 kW	
Propane G31 3.2 - 6.3 kW	

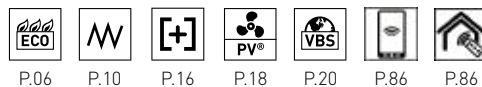

P.06 P.10 P.16 P.18 P.20 P.86 P.86

Lugo 80/3 Eco Wave





Metro 130XTL Eco Wave (right)



METRO 100XTL - 130XTL ECO WAVE

Spectacular corner fires.



Metro 100XTL Eco Wave (left)

Due to their unusual design, the Metro 100XTL - 130XTL are extremely suited for a corner between two areas, such as in a typical L-shaped living space.

Characteristics:

- Very high efficiency
- Also suited for partially suspended or semi-high built-in
- No visible frames
- Various interior finishes available
- Various fire beds available

Choose your own size:

(For precise dimensions, see p.91)



Metro 100XTL Eco Wave

B

Output range

Natural gas G20 **4.3 - 9.6 kW**
 Natural gas G25.3 **3.3 - 9.0 kW**
 Propane G31 **4.1 - 9.1 kW**

Efficiency

83.3%

Metro 130XTL Eco Wave

A

Output range

Natural gas G20 **5.1 - 10.8 kW**
 Natural gas G25.3 **4.1 - 10.2 kW**
 Propane G31 **5.6 - 10.6 kW**

Efficiency

89.6%



P.06



P.10



P.13



P.16

100XTL ONLY



P.18



P.19

100XTL ONLY



P.20



P.86



P.86

MAESTRO 80/2 ECO WAVE

The finest 2-sided fire experience.

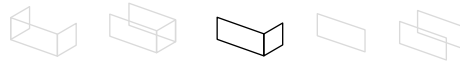

layar

Scan this page
with the Layar app.

In this corner model of the DRU Maestro Eco Wave series, the flames surround the logs, giving the feeling of a real fire.

Characteristics:

- Wide output range and complete control with Eco Wave
- Can be built in without a frame
- Left-hand and right-hand versions
- Suspended mounting

Choose your own size:

(For precise dimensions, see p.91)



Maestro 80/2 Eco Wave

A

Output range

Natural gas G20 **1.4 - 9.0 kW**
Natural gas G25.3 **1.3 - 8.6 kW**
Propane G31 **1.3 - 7.7 kW**

Efficiency

93.0%

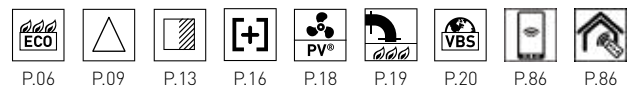

P.06 P.09 P.13 P.16 P.18 P.19 P.20 P.86 P.86

MAESTRO 105/2 ECO WAVE

The ultimate 2-sided gas fire.

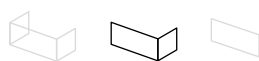

This built-in corner fire with a 2-sided view of the flames is deservedly the ultimate fire: available in left-hand or right-hand versions, a second burner that switches on/off, rotating front window, various interior finishes available, optional anti-reflective glass and a sturdy log set.

Characteristics:

- Can be built in tightly and without a frame
- Custom-made frame available
- The unique Easy release door system
- Various interior finishes
- Can be wall mounted or suspended

Choose your own size:

(For precise dimensions, see p.91)



Maestro 105/2 Eco Wave

Output range

Natural gas G20 **2.2 - 9.3 kW**
Natural gas G25.3 **1.8 - 8.7 kW**
Propane G31 **1.5 - 9.6 kW**

Efficiency

87.5%

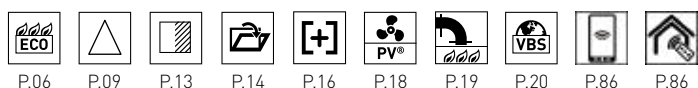

P.06 P.09 P.13 P.14 P.16 P.18 P.19 P.20 P.86 P.86



Metro 130XT/2 Eco Wave (left)

METRO 100XT/2 - 130XT/2 ECO WAVE

See both sides of the story.



Metro 100XT/2 Eco Wave (right)

Just like other Metro fires, the Metro 100XT/2 and the Metro 130XT/2 are equipped with the DRU Vario Burner. This burner guarantees high efficiency and a natural flame pattern.

Characteristics:

- The ambience from a built-in fire with 2-sided view of the flames (left-hand or right-hand version)
- No visible frames
- Various interior finishes available
- Various fire beds available

Choose your own size:

(For precise dimensions, see p.91)



100XT/2

130XT/2

Metro 100XT/2 Eco Wave

B

Output range

Natural gas G20	4.3 - 9.6 kW
Natural gas G25.3	3.3 - 9.0 kW
Propane G31	4.1 - 9.1 kW

Efficiency

83.3%

Metro 130XT/2 Eco Wave

A

Output range

Natural gas G20	5.1 - 10.8 kW
Natural gas G25.3	4.1 - 10.2 kW
Propane G31	5.6 - 10.6 kW

Efficiency

89.6%

layar

Scan this page
with the Layar app.



P.06



P.10



P.13



P.16



P.18



P.19



P.20



P.86



P.86

LUGO 70/2 - 80/2 ECO WAVE

2-Sided fires with lovely flames.



The Lugo 70/2 - 80/2 are ideal fires for placing in a corner and are available in a left-hand and right-hand versions. There is a fantastic, two-sided view of the fire, many wooden logs and beautiful flames.

Characteristics:

- Bottom frame can be removed for a tighter fit
- Lovely flame pattern with low output
- Complete freedom of installation with PowerVent®

Choose your own size:

(For precise dimensions, see p.91)



Lugo 70/2 Eco Wave



Output range	Efficiency
Natural gas G20 3.4 - 6.9 kW	91.0%
Natural gas G25.3 2.8 - 6.5 kW	
Propane G31 3.2 - 6.3 kW	

Lugo 80/2 Eco Wave



Output range	Efficiency
Natural gas G20 3.4 - 6.9 kW	91.0%
Natural gas G25.3 2.8 - 6.5 kW	
Propane G31 3.2 - 6.3 kW	

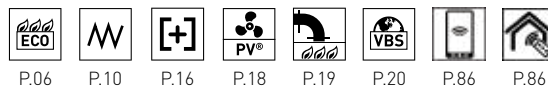

P.06 P.10 P.16 P.18 P.19 P.20 P.86 P.86



Lugo 70/2 Eco Wave (right)



PACO ECO WAVE

A versatile fire.



Paco (Inset) Eco Wave

This versatile, multi-functional fire can be placed in a corner or against a flat wall. Moreover, Paco can be entirely built-in or partly built out.

Characteristics:

- Compact size
- Lovely glow effect
- Low output

Choose your own size:

(For precise dimensions, see p.92)



Paco

Paco Eco Wave

Output range

Natural gas G20 **2.6 - 5.4 kW**

Natural gas G25.3 **2.1 - 5.0 kW**

Efficiency

84.8%

B



P.06



P.11



P.18



P.20



P.86



P.86

EXCELLENCE 50XT *ECO WAVE*

Tall or expansive gas fire.



The DRU Excellence is a gas fire with the atmosphere of a real log fire. The burner is incorporated behind a sturdy log set for a natural and life-like feeling.

Characteristics:

- A second burner can be installed separately
- Constant full flame pattern
- Remote control with thermostat
- Optional communication module for WiFi control

Choose your own size:

(For precise dimensions, see p.92)



50XT

Excellence 50XT *Eco Wave*

B

Output range

Natural gas G20 **2.3 - 7.9 kW**

Natural gas G25.3 **1.9 - 7.5 kW**

Efficiency

87.0%



P.06



P.11



P.13



P.18



P.19



P.20



P.86



P.86





layar

Scan this page
with the Layar app.

MAESTRO 75 ECO WAVE

The new generation of gas fires.



The DRU Maestro 75 provides an impressive fire experience due to its realistic logs, dense, high flames and Eco Wave smartphone or tablet controls.

Characteristics:

- Optional with Clear View (anti-reflective) glass
- Wide output range
- The base can be built in tightly and without a frame

Choose your own size:

(For precise dimensions, see p.92)



75

100

Maestro 75 Eco Wave

A

Output range

Natural gas G20 **1.3 - 9.0 kW**

Natural gas G25.3 **1.2 - 8.6 kW**

Propane G31 **1.3 - 7.9 kW**

Efficiency

89.0%



P.06

P.09

P.13

P.14

P.16

P.18

P.19

P.20

P.86

P.86





layar

Scan this page
with the Layar app.

MAESTRO 100 ECO WAVE

Superior gas fire technology.



DRU Maestro is the very latest in contemporary gas fire design. Maestro 100 is the 1 metre wide standard front model with a choice of several interiors and Clear View windows, which replicate the image of an open fire.

Characteristics:

- Choose from various interior finishes
- Wide output range
- The base can be built in tightly and without a frame

Choose your own size:

(For precise dimensions, see p.92)



75

100

Maestro 100 Eco Wave

A

Output range

Natural gas G20 **2.3 - 10.0 kW**

Natural gas G25.3 **1.9 - 9.3 kW**

Propane G31 **2.3 - 10.2 kW**

Efficiency

92.1%



P.06



P.09



P.13



P.14



P.16



P.18



P.19



P.20



P.86



P.86



Metro 100XT Eco Wave

METRO 80XT - 100XT ECO WAVE

Classic hole-in-the-wall fires.



Metro 80XT Eco Wave

The Metro 80XT - 100XT are eminently suitable for contemporary homes where space is limited. The unique burner has flames that zigzag across the entire width and depth of the fireplace.

Characteristics:

- Log set, white Carrara stones or anthracite glass (Metro 100XT only)
- Optional Ceraglass interior
- Remote control with thermostat
- Optional communication module for WiFi control

Choose your own size:

(For precise dimensions, see p.92)



Metro 80XT Eco Wave



Metro 100XT Eco Wave



Output range

Natural gas G20 **3.0 - 5.4 kW**
 Natural gas G25.3 **2.3 - 5.1 kW**
 Propane G31 **2.8 - 5.7 kW**

Efficiency

88.9%

Output range

Natural gas G20 **4.3 - 9.6 kW**
 Natural gas G25.3 **3.3 - 9.0 kW**
 Propane G31 **4.1 - 9.1 kW**

Efficiency

83.3%



P.06



P.10



P.13



P.14



P.18



P.19



P.20



P.86



P.86

100XT ONLY



Metro 130XT Eco Wave

METRO 130XT - 150XT ECO WAVE

An expansive choice.



Metro 150XT Eco Wave

Special features of these extra-wide fires are the realistic log sets and the unique burners, with flames that zigzag across the entire width and depth of the fires.

Characteristics:

- Unique flame pattern
- Available with various interior finishes
- Choose from the various fire beds

Choose your own size:

(For precise dimensions, see p.92)



Metro 130XT Eco Wave



Output range

Natural gas G20 **5.1 - 10.8 kW**
 Natural gas G25.3 **4.1 - 10.2 kW**
 Propane G31 **5.6 - 10.6 kW**

Efficiency

89.6%

Metro 150XT Eco Wave



Output range

Natural gas G20 **5.9 - 10.8 kW**
 Natural gas G25.3 **4.9 - 10.3 kW**
 Propane G31 **5.3 - 11.1 kW**

Efficiency

87.9%

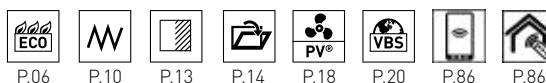

P.06

P.10

P.13

P.14

P.18

P.20

P.86

P.86

layar

Scan this page
with the Layar app.

METRO 200XT ECO WAVE

Wide, wider, widest.



The lavish Metro 200XT fire not only creates atmosphere, but also provides considerable warmth in large living spaces. A special feature of this 200 cm wide fire is its realistic log set, which is nearly indistinguishable from real logs.

Characteristics:

- Unique zigzag burner for a wide and deep fire
- Realistic log set
- Flames over the entire width of the fire
- Total control with Eco Wave

Choose your own size:

(For precise dimensions, see p.93)

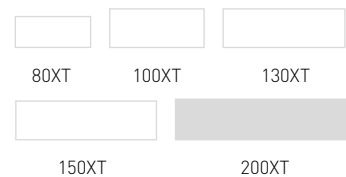

Metro 200XT Eco Wave

A

Output range

Natural gas G20 **8.9 - 16.7 kW**

Natural gas G25.3 **7.2 - 15.8 kW**

Efficiency

90.3%

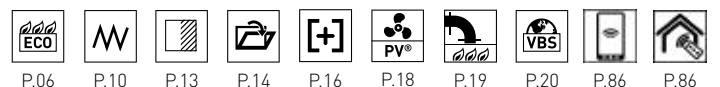

COSMO ECO WAVE

Impressive in size and output.



With its output and its impressive size of 180 cm width and 80 cm height, the Cosmo provides the ultimate ambience for large living areas.

Characteristics:

- Optional addition is the lovely Murano chimney (stainless steel casing and limestone hearth)
- Easy to clean glass due to the Easy release door system
- Wide output range and complete control with Eco Wave

Choose your own size:

(For precise dimensions, see p.93)

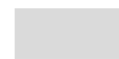

Cosmo

Cosmo Eco Wave

A

Output range

Natural gas G20 **6.0 - 16.3 kW**

Natural gas G25.3 **4.9 - 15.7 kW**

Efficiency

89.3%

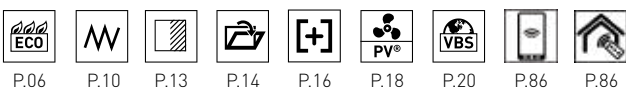

P.06

P.10

P.13

P.14

P.16

P.18

P.20

P.86

P.86

MAESTRO 75 TUNNEL *ECO WAVE*

The ultimate room divider.



The Maestro 75 Tunnel is a spectacular room divider for a dining room and living room, kitchen or even a conservatory. This fire has black side walls and a Dynamic Flame Burner®. This unique burner is built into ceramic wood logs, causing the flames to lap around them.

Characteristics:

- Suitable for installation between two rooms
- Ideal as a room divider
- Very high 92,1% efficiency
- With Easy release door system, drop down door for easy cleaning and maintenance of your fire

Choose your own size:

(For precise dimensions, see p.93)



75

Maestro 75 Tunnel Eco Wave

A

Output range

Natural gas G20 **1.7 - 9.1 kW**
 Natural gas G25.3 **1.5 - 8.5 kW**
 Propane G31 **1.9 - 9.5 kW**

Efficiency

93.0%

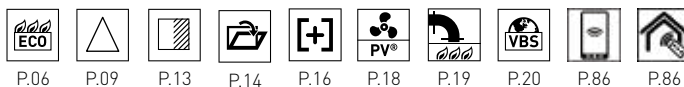

P.06

P.09

P.13

P.14

P.16

P.18

P.19

P.20

P.86

P.86



layar

Scan this page
with the Layar app.



METRO 80XT - 100XT TUNNEL ECO WAVE

Two sides of the same fire.



Metro 80XT Tunnel Eco Wave

Metro 80XT Tunnel and 100XT Tunnel enable you to enjoy the fire from two sides, making it ideal as a room divider.

Characteristics:

- Realistic log set or white Carrara stones
- Fire over the entire width
- If combined with PowerVent®, it can be installed anywhere in the home

Choose your own size: (For precise dimensions, see p.92)



Metro 80XT Tunnel Eco Wave A		Metro 100XT Tunnel Eco Wave B	
Output range	Efficiency	Output range	Efficiency
Natural gas G20 3.0 - 5.4 kW	88.9%	Natural gas G20 4.3 - 9.6 kW	83.3%
Natural gas G25.3 2.3 - 5.1 kW		Natural gas G25.3 3.3 - 9.0 kW	
Propane G31 2.8 - 5.7 kW		Propane G31 4.1 - 9.1 kW	

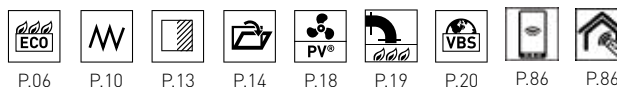

P.06 P.10 P.13 P.14 P.18 P.19 P.20 P.86 P.86
100XT TUNNEL ONLY



Metro 100XT Tunnel Eco Wave



METRO 130XT TUNNEL ECO WAVE

Dancing flames from both sides.



layar

Scan this page
with the Layar app.

Metro 130XT tunnel fire has the a unique zigzag burner that virtually fills the entire width and depth of the fire with flames.

Characteristics:

- Ideal as a room divider
- Natural log set or stones
- Also available in LPG
- Very high 89,6% efficiency
- If combined with PowerVent®, it can be placed anywhere in the house

Choose your own size:

(For precise dimensions, see p.92)

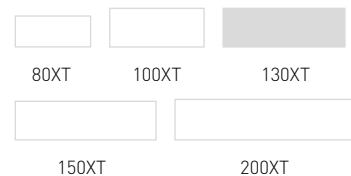

Metro 130XT Tunnel Eco Wave

A

Output range

Natural gas G20 **5.1 - 10.8 kW**
 Natural gas G25.3 **4.1 - 10.2 kW**
 Propane G31 **5.6 - 10.6 kW**

Efficiency

89.6%



P.06 P.10 P.13 P.14 P.18 P.20 P.86 P.86

METRO 150XT - 200XT TUNNEL ECO WAVE

Wide and impressive tunnel fires.



Metro 150XT Tunnel Eco Wave

This lavish 150 cm/200 cm tunnel fire not only creates a great atmosphere, but also provides considerable warmth in large areas. These impressive fires have large, realistic logs, which closely replicate the look of a real fire.

Characteristics:

- Metro 150XT Tunnel is available with authentic brown or white birch log sets
- The large glass window is easy to clean.
- Fire over the entire width
- Remote control with thermostat

Choose your own size:

(For precise dimensions, see p.92, 93)

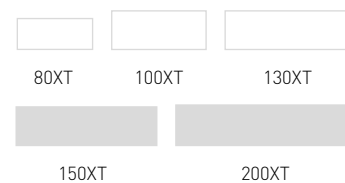

Metro 150XT Tunnel Eco Wave



Output range

Natural gas G20 **5.9 - 10.8 kW**
 Natural gas G25.3 **4.9 - 10.3 kW**
 Propane G31 **5.3 - 11.1 kW**

Efficiency

87.9%

Metro 200XT Tunnel Eco Wave



Output range

Natural gas G20 **8.9 - 16.7 kW**
 Natural gas G25.3 **7.2 - 15.8 kW**

Efficiency

90.3%

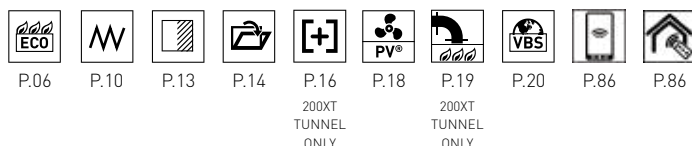

P.06

P.10

P.13

P.14

P.16

P.18

P.19

P.20

P.86

P.86

200XT
TUNNEL
ONLY

200XT
TUNNEL
ONLY

COSMO TUNNEL ECO WAVE

An impressive flame picture from both sides.



Cosmo Tunnel is designed for dividing walls or room features. Built-in tightly or combined with an impressive chimney, Cosmo Tunnel is a guaranteed eye catcher.

Characteristics:

- Suitable as a room divider
- Optional Murano chimney (stainless steel casing and limestone hearth)
- Easy release door system on both sides
- Wide output range and complete control with Eco Wave
- The base can be built in without a frame

Choose your own size:

(For precise dimensions, see p.93)



Cosmo

Cosmo Tunnel Eco Wave

A

Output range

Natural gas G20 **6.0 - 16.3 kW**

Natural gas G25.3 **4.9 - 15.7 kW**

Efficiency

89.3%

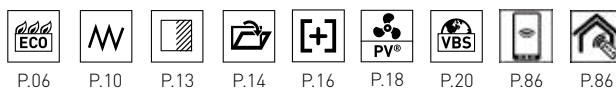

P.06

P.10

P.13

P.14

P.16

P.18

P.20

P.86

P.86





CIRCO

Beautiful cylindrical stove.



layar

Scan this page
with the Layar app.

Circo is a freestanding gas stove that makes an elegant focal point anywhere in the home. The curved window offers a view from several corners of the room.

Characteristics:

- Programmable timer that can set the temperature to a comfortable level or a rest level
- Remote control with thermostat

Choose your own size:

(For precise dimensions, see p.93)



Circo

Circo

A

Output range

Natural gas G20 **2.9 - 7.0 kW**

Natural gas G25.3 **2.7 - 6.0 kW**

Propane G31 **2.8 - 6.2 kW**

Efficiency

92.5%

POLO

Stylish and functional gas stove.



layar

Scan this page
with the Layar app.

Due to its limited output of around 4 kW, this beautiful three-sided free-standing gas stove is very suitable for wellinsulated and small rooms such as kitchens, conservatories or living rooms.

Characteristics:

- Moderate heat output
- Various interior finishes available
- Programmable timer that can set the temperature to a comfortable level or a rest level

Choose your own size:

(For precise dimensions, see p.93)



Polo

Polo

A

Output range

Natural gas G20 **1.6 - 4.1 kW**
Natural gas G25.3 **1.5 - 3.8 kW**
Propane G31 **1.6 - 3.8 kW**

Efficiency

92.6%



P.11



P.20



P.86

TRIO

Elegant and powerful.



Trio is a freestanding stove with a slender form and an imposing look. It makes a beautiful centrepiece in a large or small living room.

Characteristics:

- A fire with a 3D-effect, visible from several locations in the room
- High display of flames with a glowing effect
- Remote control with thermostat

Choose your own size:

(For precise dimensions, see p.93)



Trio

Trio

B

Output range

Natural gas G20 **2.0 - 4.5 kW**
Natural gas G25.3 **1.8 - 4.2 kW**
Propane G31 **1.5 - 4.0 kW**

Efficiency

85.4%



P.11

P.20

P.86

DIABLO NEXT

Fits everywhere.



Due to its limited output of around 4 kW, this beautiful three-sided suspended gas fire is very suitable for all types of room.

Characteristics:

- Wall mountable, takes no floor space
- Available in black or aluminium-metallic finish
- Optional ornamental frame available for concealing the flue pipe
- Remote control with thermostat

Choose your own size:

(For precise dimensions, see p.93)



Diablo

Diablo Next

Output range

Natural gas G20 **1.6 - 4.1 kW**
Natural gas G25.3 **1.5 - 3.8 kW**
Propane G31 **1.6 - 3.8 kW**

Efficiency

92.6%



P.11

P.20

P.86

LUGO 70/3 MODULE ECO WAVE

Easy to install with choice of colours.



Lugo 70/3 Module is a three-sided fire equipped with the Eco Wave burner technology that allows you to set 15 different flame pattern levels .

Characteristics:

- Very realistic log set
- Always a full flame pattern
- Impressive view from all three sides
- Available in three types of stone finish
- Remote control with thermostat
- Optional communication module for WiFi control

Choose your own size:

(For precise dimensions, see p.93)



Lugo 70/3 Module

The features of the stone finish

- Resistant to extremely high temperatures
- Scratch-resistant
- Easy to clean
- 100% natural and recyclable

A

Lugo 70/3 Module Eco Wave

Output range

Natural gas G20 **3.4 - 6.9 kW**
 Natural gas G25.3 **2.8 - 6.5 kW**
 Propane G31 **3.2 - 6.3 kW**

Efficiency

91.0%



P.06



P.10



P.20



P.86



P.86

PASSO ECO WAVE

180 degrees view of the fire.



This cool free-standing gas fire catches the eye thanks to its large round glass window. The flame patterns can be regulated by means of the integrated Eco Wave technology. The glowing effect at the bottom of the gas fire and high-stacked logs create a beautiful fire. The gas fire can be operated with a remote control or through your smartphone or tablet.

Passo Eco Wave

Characteristics:

- Revolving door for easy cleaning
- Available in 3 colours
- Beautiful high flame display and low gas use



Nero



Titan



Pearl white

Choose your own size:

(For precise dimensions, see p.93)



Passo

A

Output range

Natural gas G20 **2.2 - 7.0 kW**

Natural gas G25.3 **2.0 - 6.7 kW**

Propane G31 **1.9 - 6.5 kW**

Efficiency

90,0%



P.06



P.09



P.14



P.20



P.86



P.86

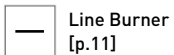

Line Burner
[p.11]

The Line Burner provides a lovely tight flame pattern over the width of the fire.



Global Truflame Burner®
[p.12]

Double log burner for a wide/deep fire and a very high flame picture.



Direct flue
[p.19]

Directly on the fire via a 90° pipe bend to the outside.



Safety Control System
(Dutch: VBS) [p.20]

These fires are completely suitable for various types of gasses and fully prepared for the future.



[p.20]

The Global gas fire collection consists fires with open combustion (Conventional Flue) and fires with closed combustion (Balanced Flue).



Domotica Home Automation [p.86]

Possibility to connect to home automation systems for smart control in the home.

...TO MAKE *you* FEEL AT HOME

GLOBAL BY DRU PRODUCT RANGE

Global gas fires are perfectly well balanced between desirability and affordability. With so many options, there is always a fire that fits with your interior design.

Due to their **shallow depth**, the compact Global gas fires are suitable for nearly every room, regardless of whether you live in a mid-terrace house or an apartment. **Installing is simple, prices are attractive, the quality is excellent** and the many options allow you to personalise your fire. That makes Global gas fires suitable for virtually everyone.

In the Global gas fire collection, you can select front fires with one side in glass, 2-sided and 3-sided fires for a view of the flames from various angles, and freestanding gas stoves.

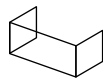

3-Sided fires
[p. 75]

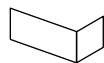

2-Sided fires
[p. 78]



Front fires
[p. 70, 80]



Freestanding fires
[p. 74]



GLOBAL 40 CF

For easy chimney insertion.



Global 40 CF is the ideal fire if your living room is small, but you want to enjoy the ambience of a fire.

Characteristics:

- Compact size
- Sufficient output of around 3 kW
- Suited for a standard chimney
- Remote control with a thermostat and clock

Choose your own size:

(For precise dimensions, see p.94)

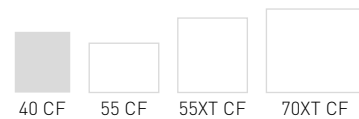

Global 40 CF



Output range

Natural gas G20 **1.6 - 3.3 kW**
Natural gas G25.3 **1.3- 3.1 kW**
Propane G31 **1.5 - 3.1 kW**

Efficiency

81.1%

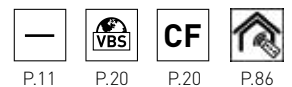

P.11

P.20

P.20

P.86

GLOBAL 55 CF

Compact and convenient gas fire.



The Global 55 CF is a gas fire with minimal built-in depth. Therefore the fire takes up little space and, partly on account of its relatively low output, is superb for smaller living spaces.

Characteristics:

- Compatible with existing chimneys
- Remote control with a thermostat and clock
- Shallow built-in depth

Choose your own size:

(For precise dimensions, see p.94)

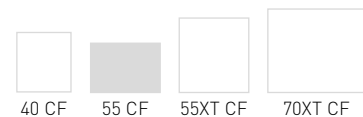

Global 55 CF



Output range

Natural gas G20 **1.9 - 3.9 kW**
Natural gas G25.3 **1.5 - 3.7 kW**
Propane G31 **1.9 - 4.0 kW**

Efficiency

77.7%

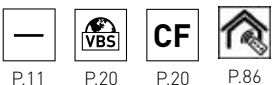

P.11 P.20 P.20 P.86

GLOBAL 55XT CF - 70XT CF

Transform your old fireplace.



Global 70XT CF

The Global 55XT CF and 70XT CF are excellent additions to the attractively priced Global product range. It can be built into an existing chimney, with no visible openings.

Characteristics:

- Extra depth by means of a flat rear wall
- Stone interior finish: Classic or romantic
- Various interior finishes
- Remote control with a thermostat and clock

Choose your own size:

(For precise dimensions, see p.94)

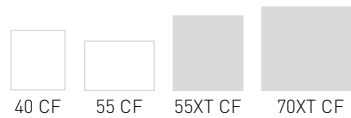

Global 55XT CF



Output range

Natural gas G20 **1.7 - 4.5 kW**
 Natural gas G25.3 **1.7 - 4.2 kW**
 Propane G31 **1.8 - 4.4 kW**

Efficiency

74.3%

Global 70XT CF



Output range

Natural gas G20 **2.0 - 4.7 kW**
 Natural gas G25.3 **2.0 - 4.6 kW**
 Propane G31 **2.9 - 4.8 kW**

Efficiency

77.4%



Global 55XT CF



GLOBAL BEAU CF

A great value gas stove.



Global Beau CF is a compact freestanding gas stove with a moderate heat output, ideal for a smaller living room with an existing chimney.

Characteristics:

- Available in ivory or black
- Compatible with an existing fireplace
- Remote control with a thermostat and clock

Choose your own size:

(For precise dimensions, see p.94)



BEAU CF



Global Beau CF

Output range

Natural gas G20 **1.6 - 3.3 kW**
Natural gas G25.3 **1.3 - 3.1 kW**
Propane G31 **1.5 - 3.1 kW**

Efficiency

81.1%

C

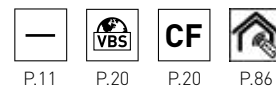

P.11

P.20

P.20

P.86

GLOBAL 60 TRIPLE BF

3-sided view of the fire.



With this stylish 3-sided fire you have a great view of the fire from every corner of your room.

Characteristics:

- Choose from two types of interior finishes
- Countless options for building in
- Very shallow built-in depth
- Remote control with a thermostat and clock

Choose your own size:

(For precise dimensions, see p.94)



60 Triple BF

100 Triple BF

120 Triple BF

Global 60 Triple BF

A

Output range

Natural gas G20 **2.3 - 6.0 kW**

Natural gas G25.3 **2.1 - 5.4 kW**

Propane G31 **3.0 - 6.2 kW**

Efficiency

91.5%



P.11

P.19

P.20

P.20

P.86

GLOBAL 100 TRIPLE BF - 120 TRIPLE BF

All round style and comfort.



The compact design of the Global 100 and 120 Triple BF is characterised by its minimal frames and a wide panoramic fire display.

Characteristics:

- Limited built-in depth of 38 cm
- Fits into any type of interior
- High efficiency of 94.0%
- Remote control with a thermostat and clock

Choose your own size:

(For precise dimensions, see p.94)

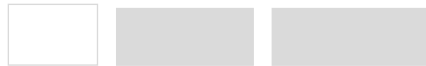

60 Triple BF 100 Triple BF 120 Triple BF

Global 100 Triple BF



Output range

Natural gas G20 **2.8 - 7.5 kW**
 Natural gas G25.3 **2.6 - 7.1 kW**
 Propane G31 **3.5 - 7.0 kW**

Efficiency

94.0%

Global 120 Triple BF



Output range

Natural gas G20 **2.8 - 7.5 kW**
 Natural gas G25.3 **2.6 - 7.1 kW**
 Propane G31 **3.5 - 7.0 kW**

Efficiency

94.0%



P.11 P.19 P.20 P.20 P.86



Global 100 Triple BF



layar

Scan this page
with the Layar app.

GLOBAL 60 CORNER BF

Beautiful 2-sided gas fire.

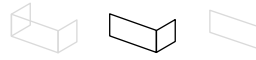

Global 60 Corner BF is very suitable for positioning in a corner, providing you with a view of the fire from two sides.

Characteristics:

- Very shallow built-in depth
- Available with two interiors: smooth black or Ceraglass
- Remote control with a thermostat and clock

Choose your own size:

(For precise dimensions, see p.95)

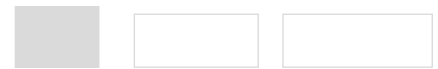

60 Corner BF 100 Corner BF 120 Corner BF

Global 60 Corner BF

A

Output range

Natural gas G20 **2.3 - 6.0 kW**
Natural gas G25.3 **2.1 - 5.4 kW**
Propane G31 **3.0 - 6.2 kW**

Efficiency

91.5%



P.11 P.19 P.20 P.20 P.86

GLOBAL 100 CORNER BF - 120 CORNER BF

A 2-sided fireplace experience.

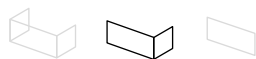

Global 120 Corner BF (left)

Global 100/120 Corner BF is characterised by a wide panoramic front view of the fire. The open view on the left and right side allows you to enjoy the fire on two sides.

Characteristics:

- Shallow built-in depth of 36 cm
- Minimalist frames
- High efficiency
- Remote control with a thermostat and clock

Choose your own size:

(For precise dimensions, see p.95)

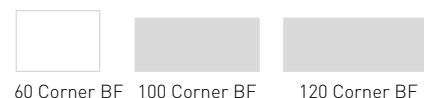

60 Corner BF 100 Corner BF 120 Corner BF

Global 100 Corner BF

A

Output range

Natural gas G20 **2.8 - 7.5 kW**
 Natural gas G25.3 **2.6 - 7.1 kW**
 Propane G31 **3.5 - 7.0 kW**

Efficiency
94.0%

Global 120 Corner BF

A

Output range

Natural gas G20 **2.8 - 7.5 kW**
 Natural gas G25.3 **2.6 - 7.1 kW**
 Propane G31 **3.5 - 7.0 kW**

Efficiency
94.0%



P.11 P.19 P.20 P.20 P.86

GLOBAL 55XT CAVITY BF

The perfect solution. No Chimney - No space lost - Perfect flames.



The perfect fireplace solution for homes with no chimney

The new DRU Global 55XT Cavity BF wall fire is the perfect solution for homes without a traditional chimney or where a false chimneybreast is not an option. With its slim depth and perfect log flame effect, created by the unique Global Truflame Burner®, this stunning fire can easily be installed into your home's cavity wall without losing valuable floor space. With its rear-vented balanced flue, the Global 55XT Cavity BF wall gas fire is the perfect solution for any home.

Characteristics:

- Suitable for installation in a cavity
- Depth only 255 mm
- Eccentric concentric flue (Ø 150/100 mm) on left side
- Snorkel flue and convection box included
- With unique Global Truflame Burner®, burner is built into ceramic wood logs, causing the flames to lap around them

Choose your own size:

(For precise dimensions, see p.95)



55XT
CAVITY
BF



Global Truflame Burner®



Global 55XT Cavity BF



Output range

Natural gas G20 **1.8 - 3.2 kW**

Efficiency

77.1%



P.12



P.13



P.20



P.20



P.86





GLOBAL 55XT BF – 70XT BF

Gas fires with very realistic high and dense flames.



Global 55XT BF

These built-in front fires are provided with a unique Global Truflame Burner®. This burner is built into ceramic wood logs, causing the flames to lap around them and looks like a real wood fire. Both fires have a choice of different types of interior finish.

Characteristics:

- With unique Global Truflame Burner®
- Realistic fire view with a wide glow effect
- Shallow built-in depth
- Optional Clear View (anti-reflective) glass

Choose your own size:

(For precise dimensions, see p.95)

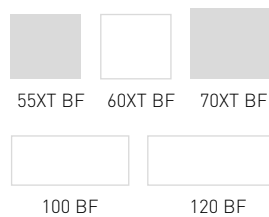

Global 55XT BF



Output range

Natural gas G20 **2.8 - 5.0 kW**
 Natural gas G25.3 **2.6 - 4.7 kW**
 Propane G31 **3.0 - 5.2 kW**

Efficiency

90.0%

Global 70XT BF



Output range

Natural gas G20 **3.8 - 6.0 kW**
 Natural gas G25.3 **3.7 - 5.8 kW**
 Propane G31 **2.9 - 4.8 kW**

Efficiency

91.0%



Global 70XT BF



Scan this page
with the Layar app.



GLOBAL 60XT BF

Compact and captivating.



Global 60XT BF is a compact and impressive built-in fire. The narrow frame and the shallow built-in depth makes it very suitable for rooms where space is limited

Characteristics:

- Front fire view
- Narrow frames
- Very shallow built-in depth
- Various interior finishes available
- Remote control with a thermostat and clock

Choose your own size:

(For precise dimensions, see p.95)

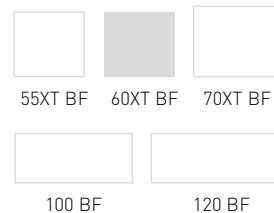

Global 60XT BF

Output range

Natural gas G20 **2.5 - 6.5 kW**
Natural gas G25.3 **2.3 - 6.0 kW**
Propane G31 **3.3 - 6.8 kW**

Efficiency

91.9%

A

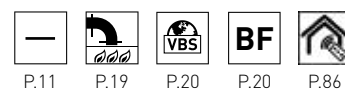

GLOBAL 100 BF - 120 BF

Beautiful landscape gas fires.



Global 100 BF and 120 BF are built-in fires with high efficiency and a wide panoramic view of the fire flames.

Characteristics:

- Shallow built-in depth
- Very high efficiency
- Attractive price
- Remote control with a thermostat and clock

Choose your own size:

(For precise dimensions, see p.95)



55XT BF 60XT BF 70XT BF



100 BF 120 BF

Global 100 BF



Output range

Natural gas G20 **2.8 - 7.5 kW**
 Natural gas G25.3 **2.6 - 7.1 kW**
 Propane G31 **3.5 - 7.0 kW**

Efficiency

94.0%

Global 120 BF



Output range

Natural gas G20 **2.8 - 7.5 kW**
 Natural gas G25.3 **2.8 - 7.1 kW**
 Propane G31 **3.5 - 7.0 kW**

Efficiency

94.0%



P.11 P.19 P.20 P.20 P.86

REMOTE CONTROL, APP, CONTROL HATCH

Useful accessories that make your life easier.

ADDED CONVENIENCE

To make it easier to use your fire, there are various accessories available (depending on the type of fire).



RCH remote control (DRU)

- robust look
- extensive control functions
- Honeywell control



RCE remote control (DRU and Global by DRU)

- modern design
- easy to use
- Mertik control



Domotica Home Automation

- connection to various home automation systems
- switching on and off and adjustable flame height
- switchable 2nd burner (where applicable)
- for both Honeywell and Mertik controls

All remote controls have electronic ignition, thermostat and clock.



App + communication module

Do you want to have full control of the flame pattern? Choose the Eco Wave communication module. With a DRU Control App that you can download for free to your smartphone and tablet (IOS/Android), you not only control the fire, but you also set the flame pattern. This is suitable only for fires with the Eco Wave system.



Management module

DRU and ICY developed a module specifically for the recreation sector (holiday parks, hotels, etc.) to operate gas fires on site as well as from a reception system.

- Includes movement and light sensors for conscious use of energy
- Innovative and easy to use
- Separate remote control and batteries are no longer necessary



Control hatch

For maintenance and in case of faults, DRU has developed a special control hatch that integrates nicely into the set-up of the fire and allows easy access to the gas regulating block.

LUXURY ELEMENTS

Cove ventilation for the protection of your casing.

LUX-URIOUS DESIGN

When using your fire, heat builds up in the casing. It is therefore necessary to ventilate in order not to cause cracks. For this purpose, DRU has developed various LUX elements in ivory-white, alu-metallic and anthracite. These are integrated into the casing and can also have the option of providing supplementary light.



Lux Fino



Lux Sleeve



Lux Lignum



Lux Omni

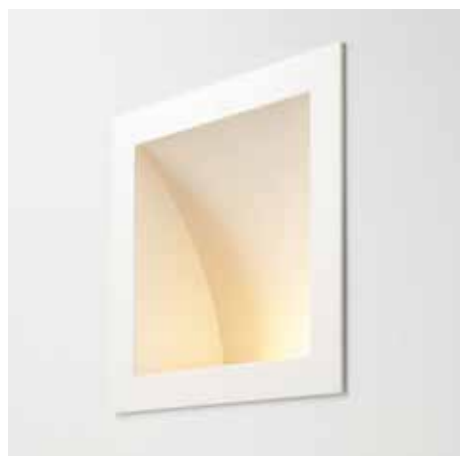

Lux

DEALERS

Our authorised dealers offer you knowledge, expertise and inspiration.

ADVICE AND INSPIRATION

DRU-Dealer

An authorised DRU dealer is a gas fire professional. He gets support from us, he is routinely trained and has extensive knowledge about products, service and installation. He takes your wishes into account and always give you tailored advice.

	Where can I see these fires?	Where can I buy such a fire?
DRU Dealer	✓	✓





LINE DRAWINGS

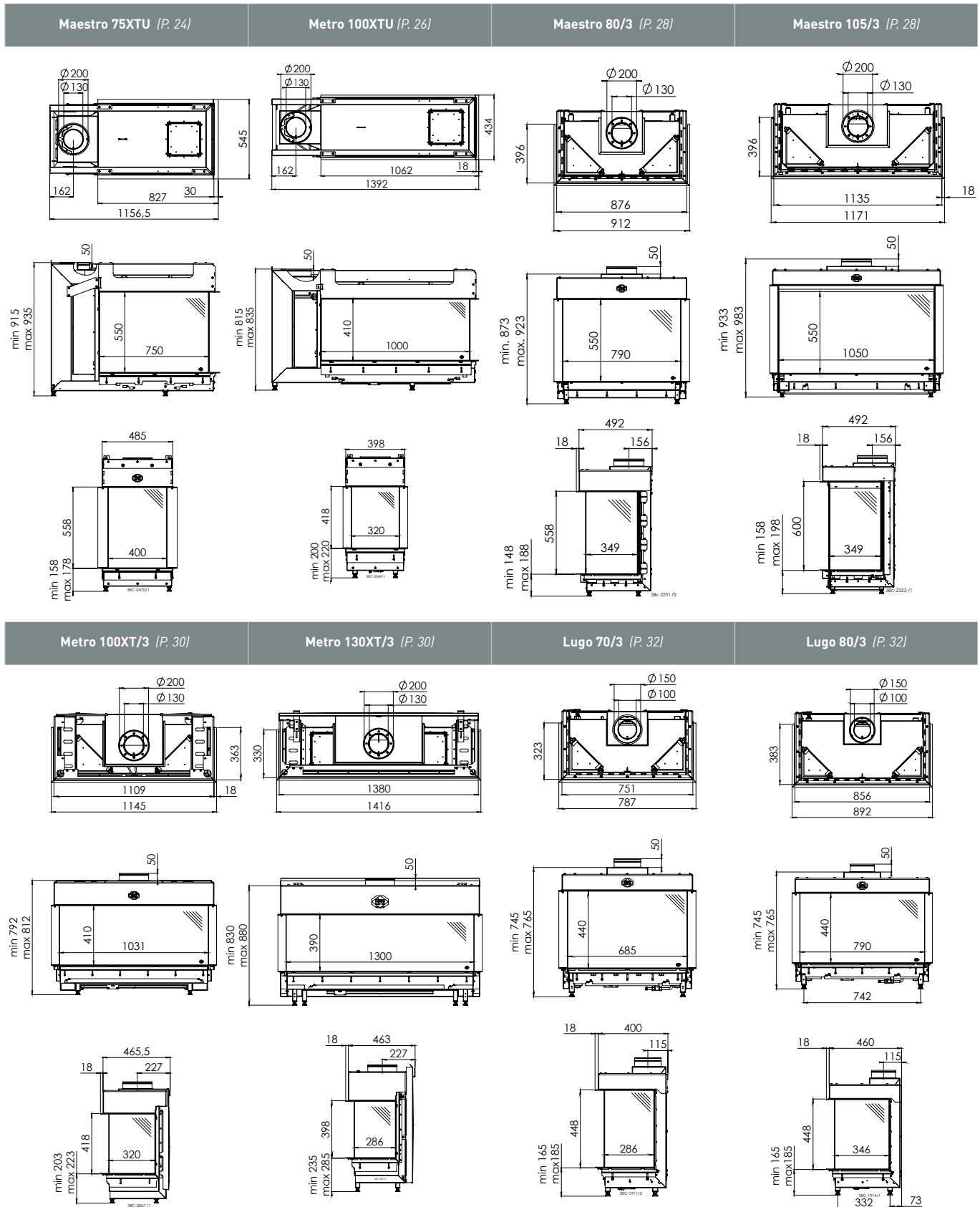

Metro 100XTL (P. 34)

Metro 130XTL (P. 34)

Maestro 80/2 (P. 36)

Maestro 105/2 (P. 37)

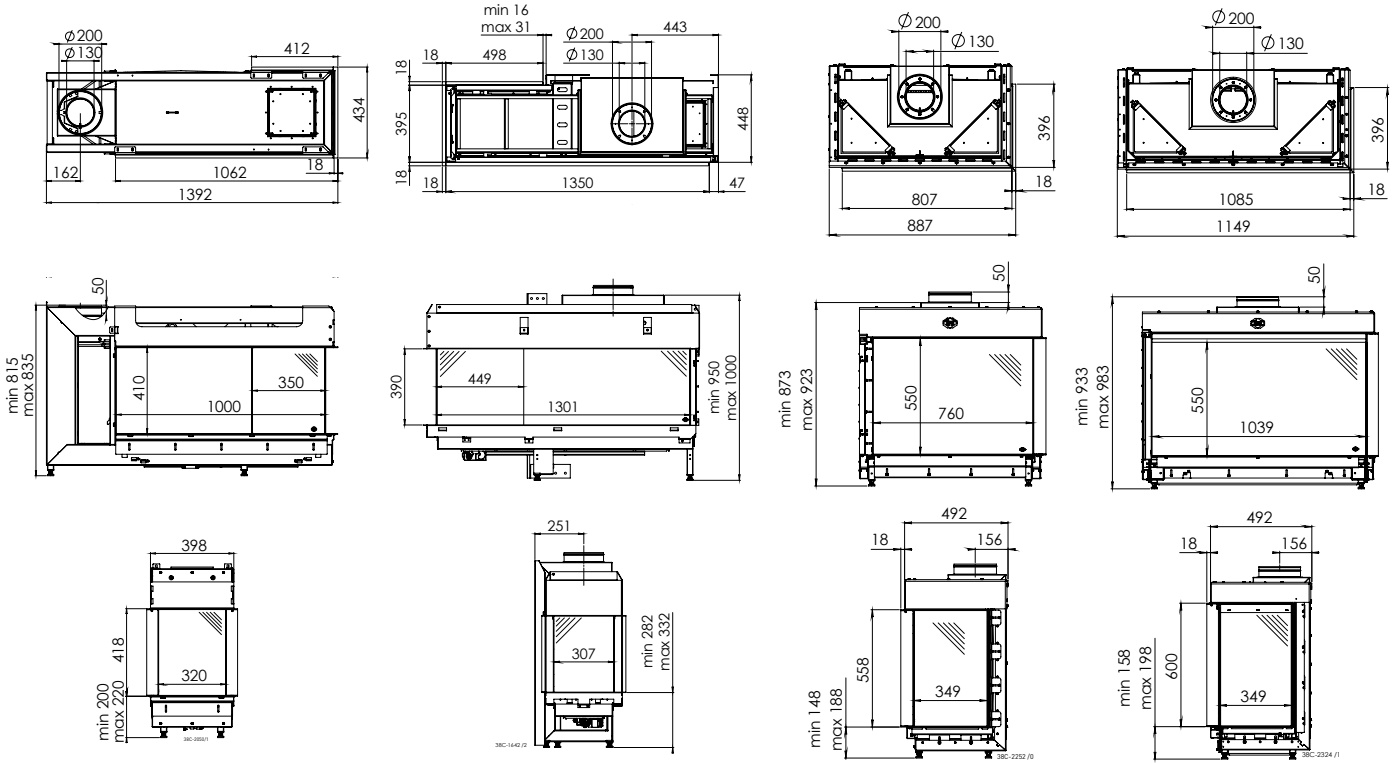

Metro 100XT/2 (P. 38)

Metro 130XT/2 (P. 38)

Lugo 70/2 (P. 40)

Lugo 80/2 (P. 40)

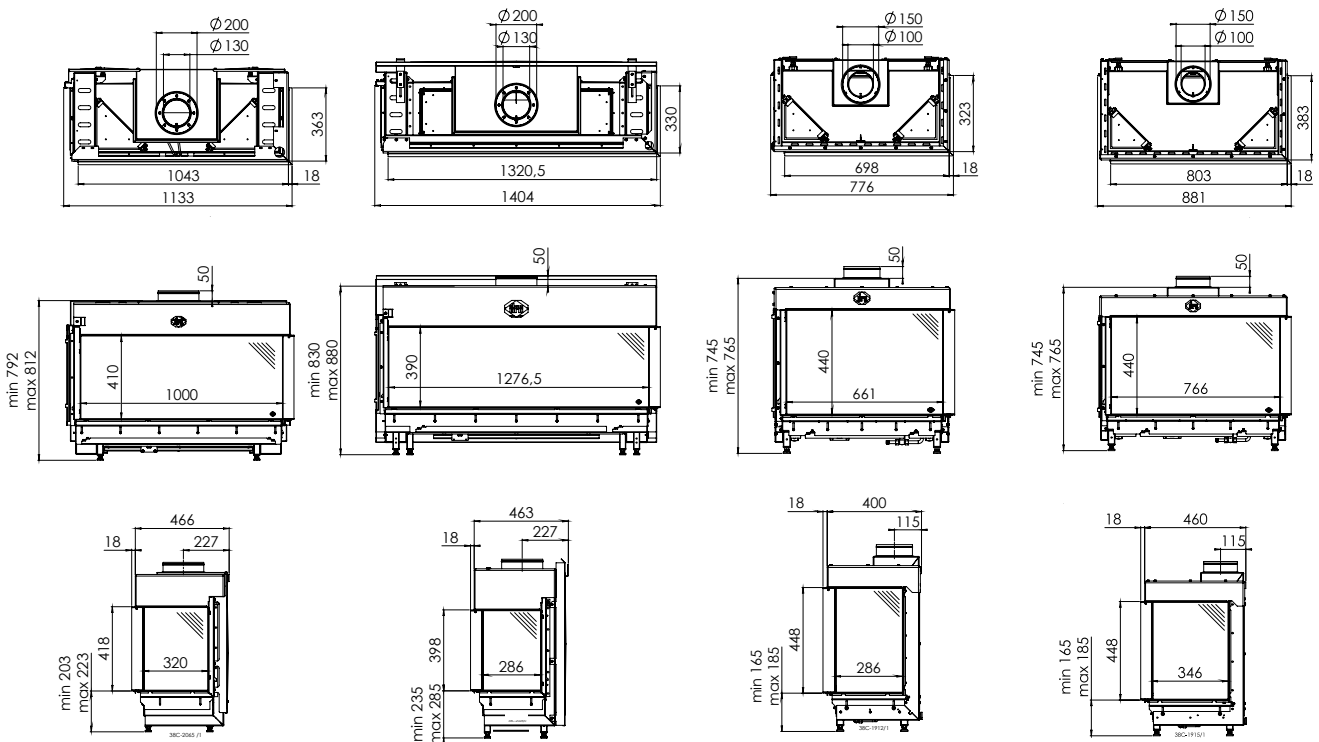

LINE DRAWINGS

Paco [P. 42]	Excellence 50XT [P. 43]	Maestro 75 Tunnel [P. 44, 54]	Maestro 100 [P. 46]
--------------	-------------------------	---------------------------------	---------------------

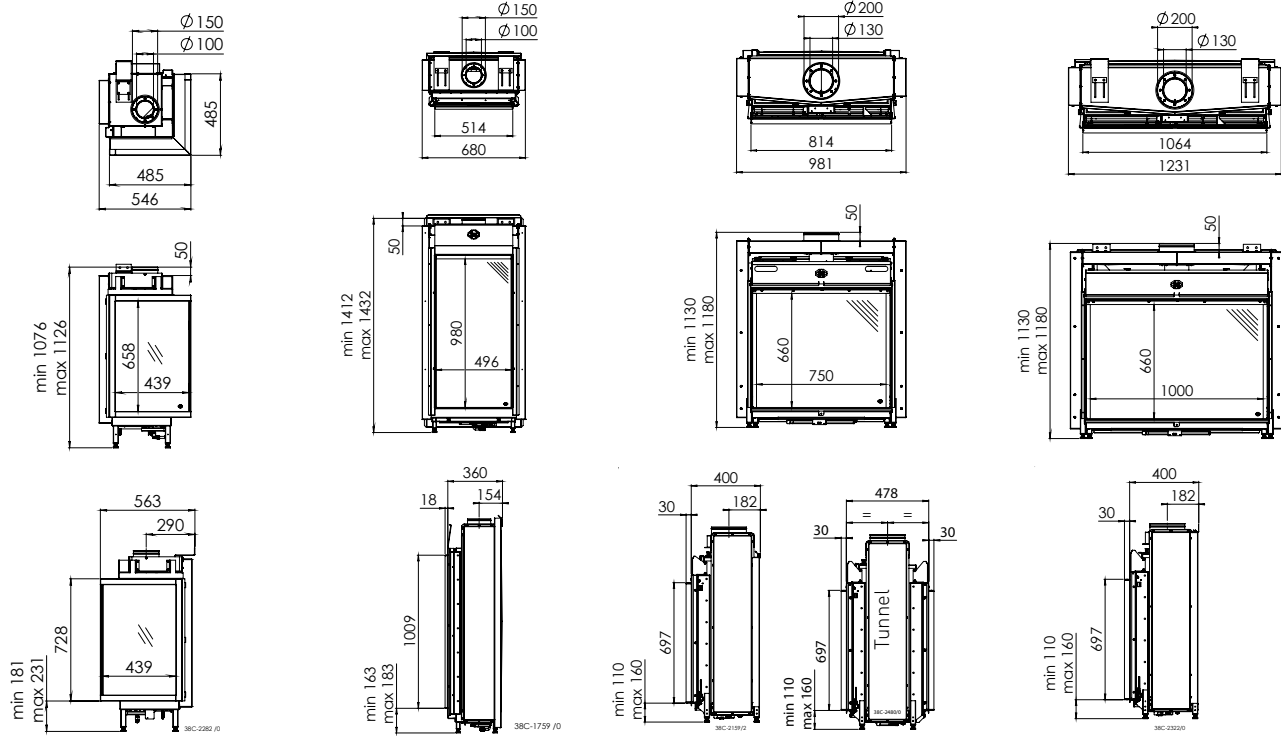

Metro 80XT Tunnel [P. 48, 56]	Metro 100XT Tunnel [P. 48, 56]	Metro 130XT Tunnel [P. 50, 58]	Metro 150XT Tunnel [P. 50, 59]
---------------------------------	----------------------------------	----------------------------------	----------------------------------

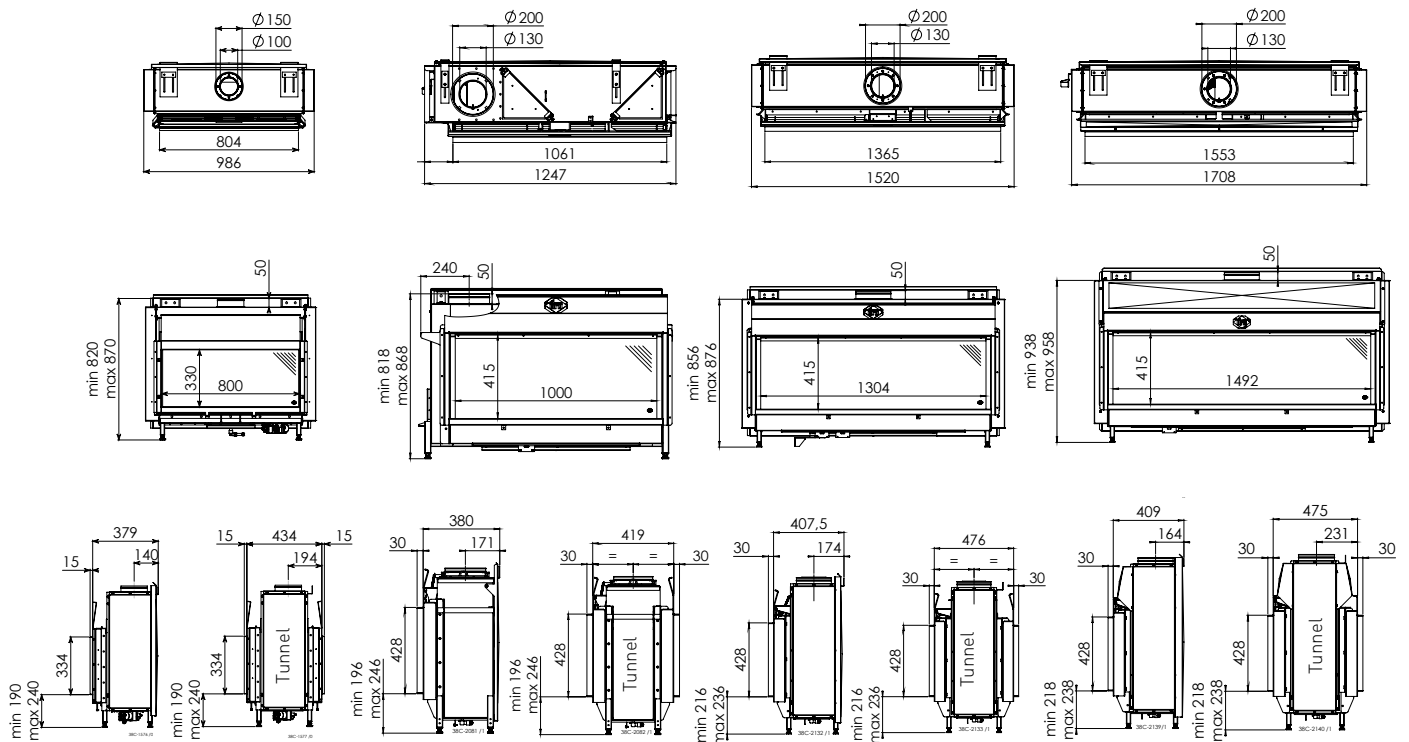

Metro 200XT | Tunnel (P. 52, 59)

Cosmo | Tunnel (P. 53, 60)

Circo (P. 62)

Polo (P. 63)

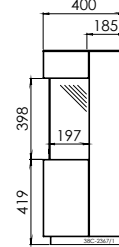
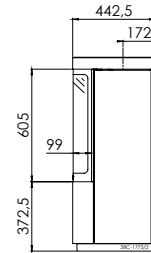
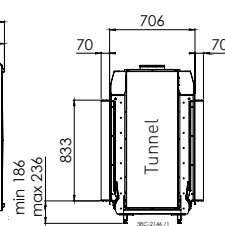
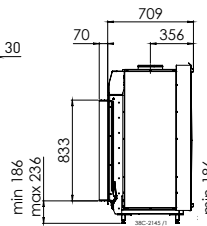
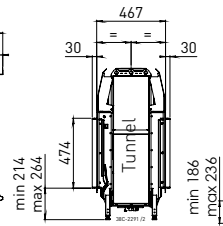
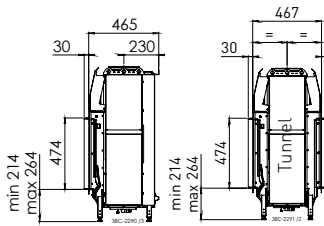
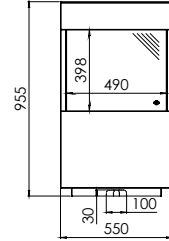
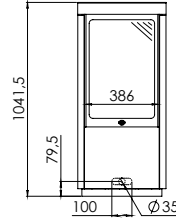
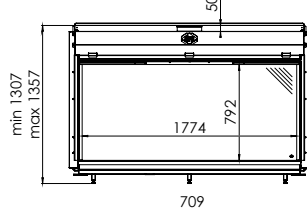
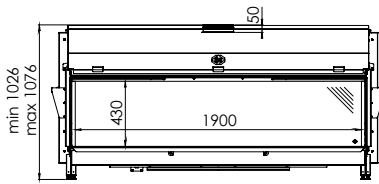
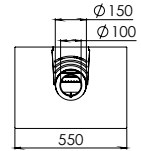
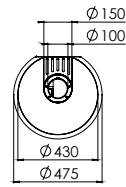
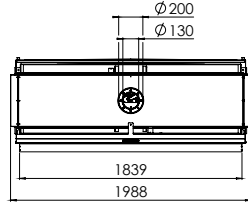
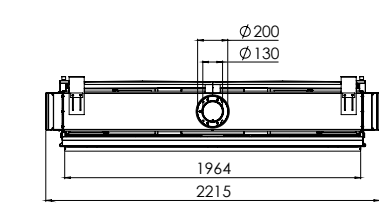

Trio (P. 64)

Diablo Next (P. 65)

Lugo 70/3 Module (P. 65)

Passo (P. 67)

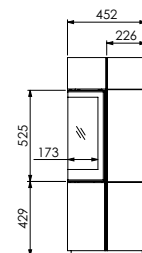
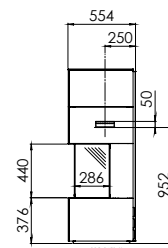
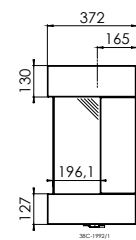
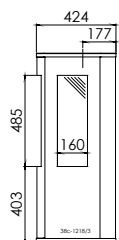
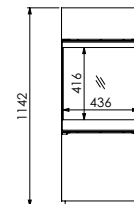
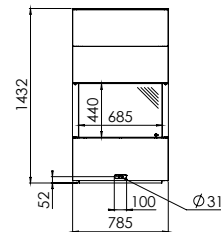
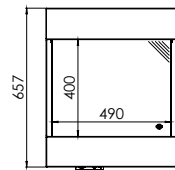
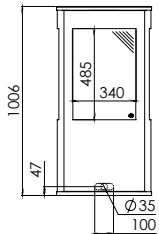
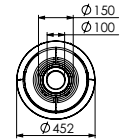
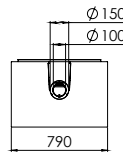
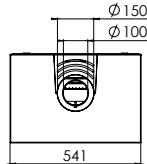
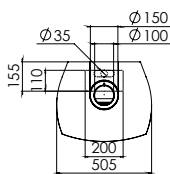

LINE DRAWINGS

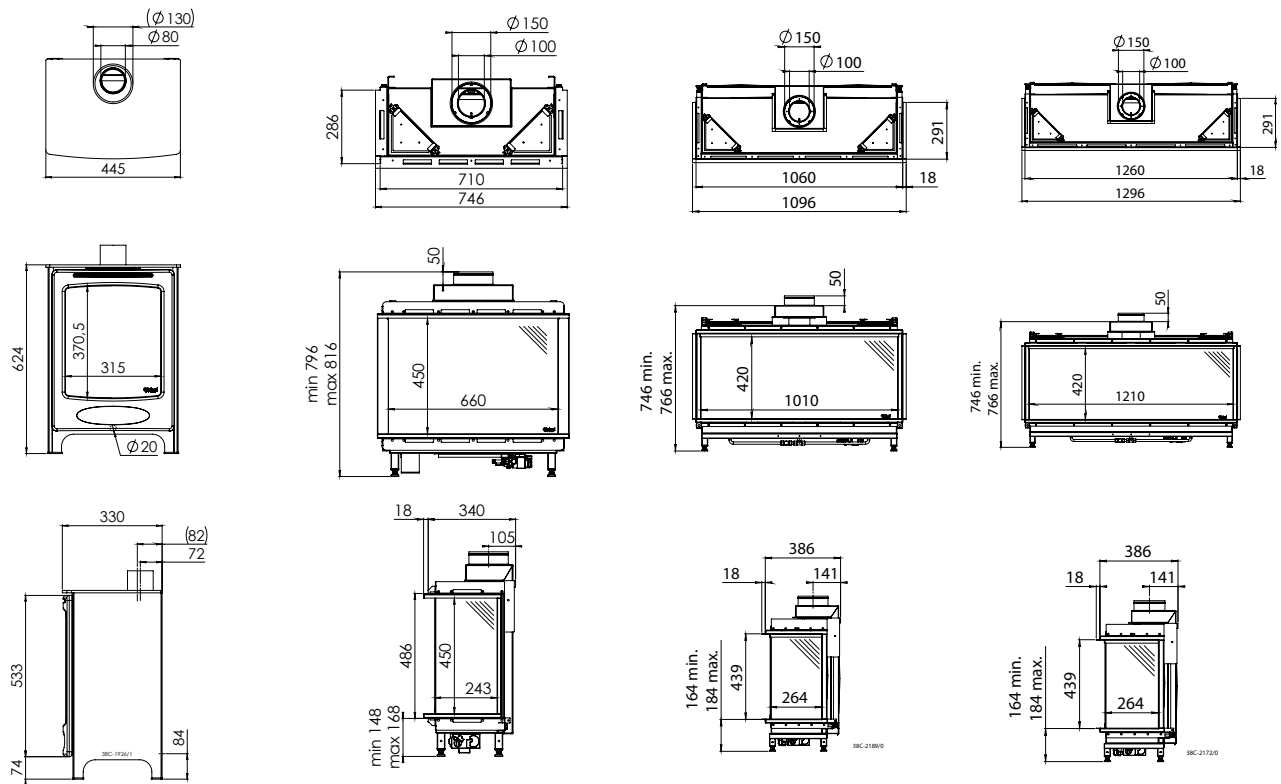
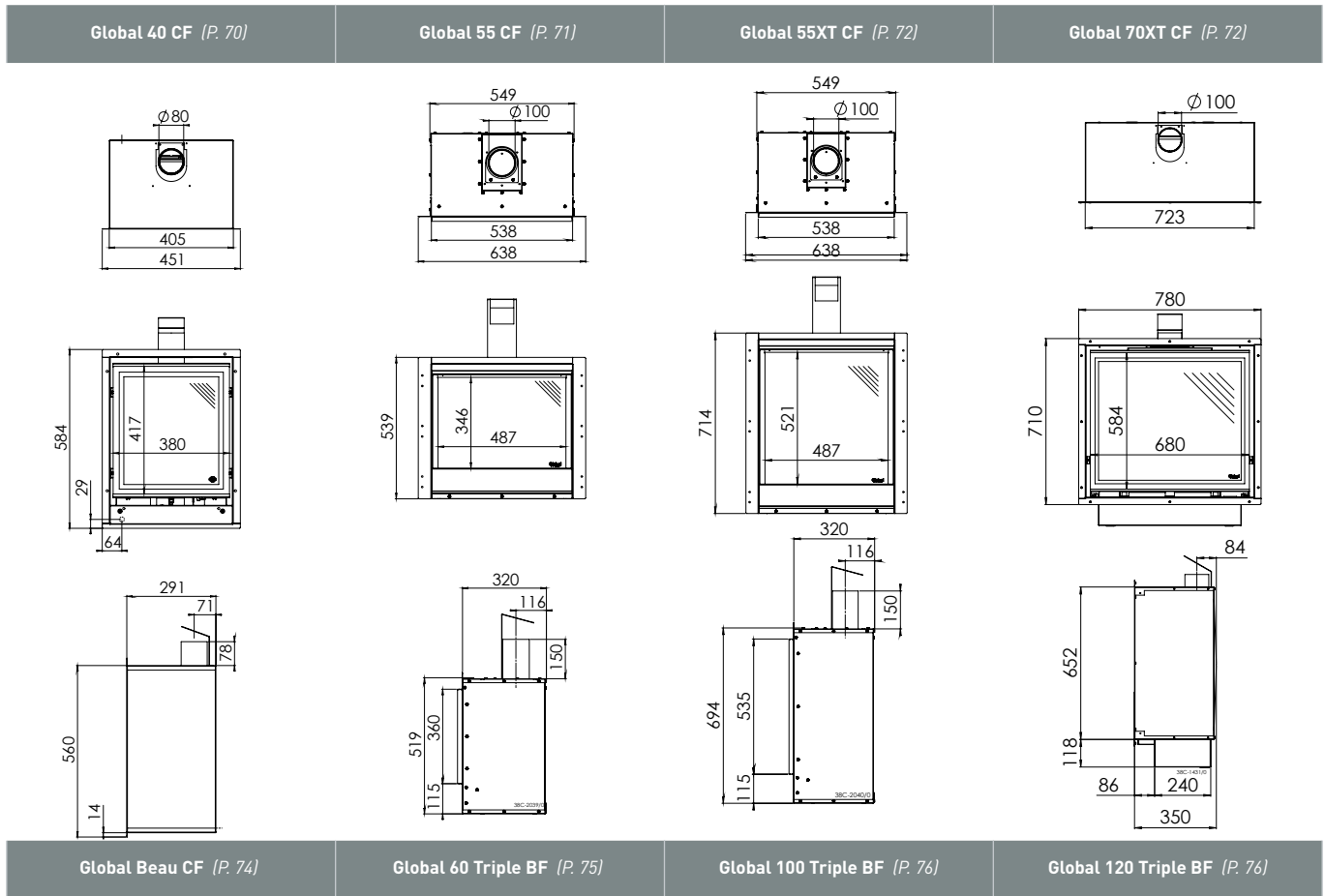

Global 60 Corner BF (P. 78)

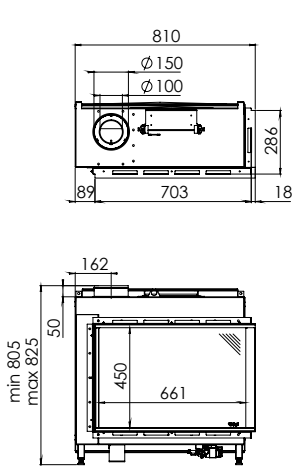

Global 100 Corner BF (P. 79)

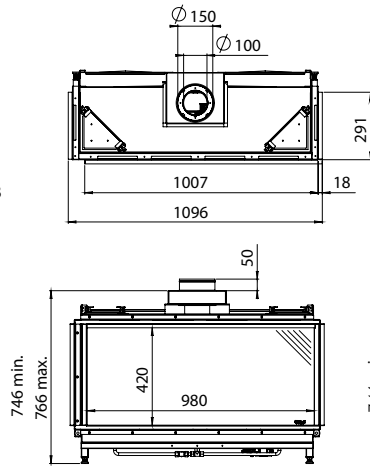

Global 120 Corner BF (P. 79)

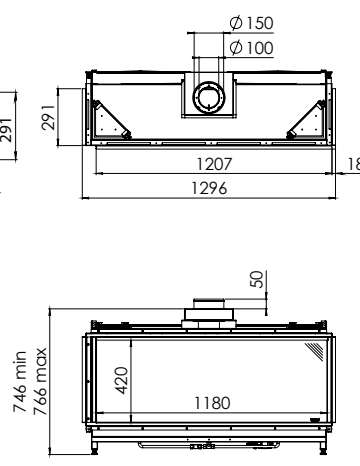

Global 55XT Cavity BF (P. 80)

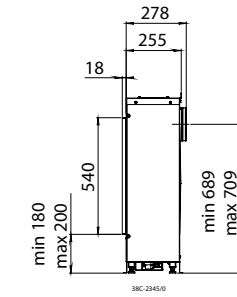
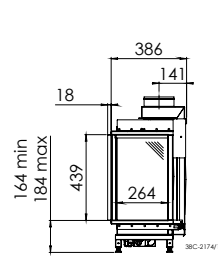
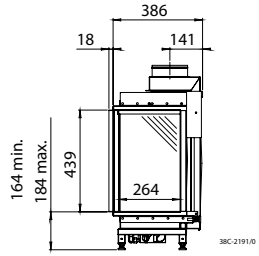
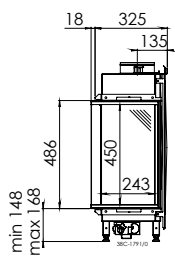
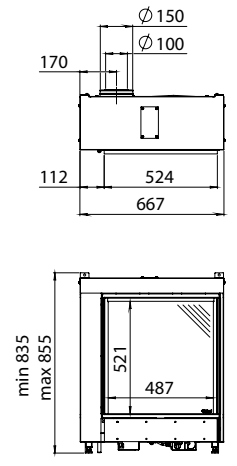

Global 55XT BF (P. 82)

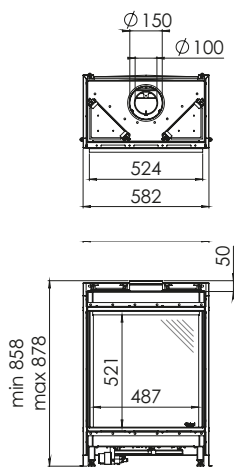

Global 70XT BF (P. 82)

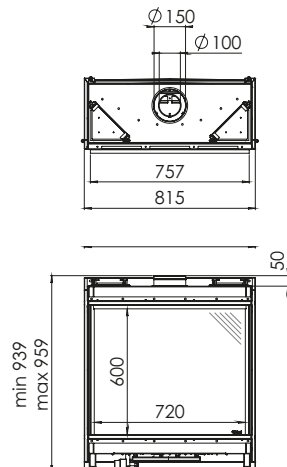

Global 60XT BF (P. 84)

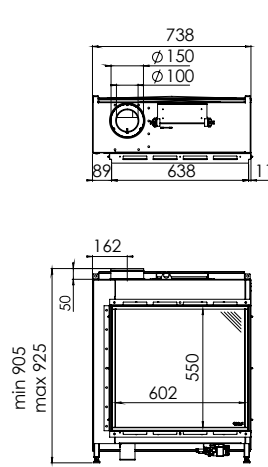

Global 100 BF | 120 BF (P. 85)

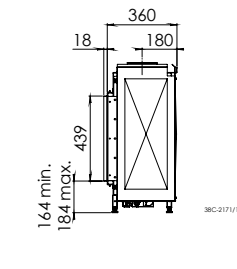
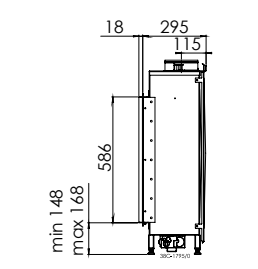
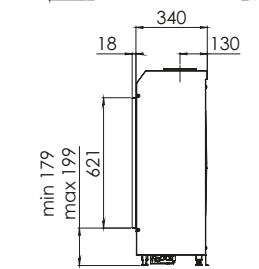
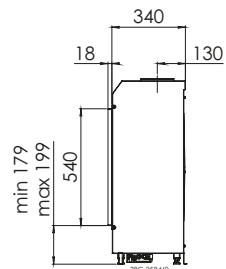
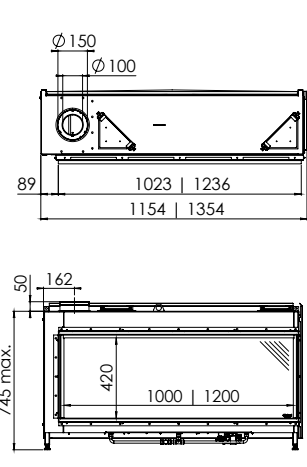



TECHNICAL SPECIFICATIONS

	Page	Net capacity kW (p.06)			Efficiency			Propane G31	Duct Ø	Built-in depth	Control hatch (p.86)		RCH
		Natural gas G20	Natural gas G25.3 (NL)	Propane G31	(%) G20	Natural gas G20	Natural gas G25.3 (NL)				RCE	RCH	
3-SIDED FIRES (closed combustion)													
Maestro 75XTU Eco Wave	24	1.2 - 8.8	1.2 - 8.4	1.9 - 9.5	93.3	A	A	A	200/130	545	+	-	+
Metro 100XTU Eco Wave	26	4.3 - 9.6	3.3 - 9.0	4.1 - 9.1	83.3	B	B	B	200/130	434	+	-	+
Maestro 80/3 Eco Wave	28	1.4 - 9.0	1.3 - 8.6	1.3 - 7.7	93.0	A	A	A	200/130	492	+	-	+
Maestro 105/3 Eco Wave	29	2.2 - 9.3	1.8 - 8.7	1.5 - 9.6	87.5	A	A	A	200/130	492	+	-	+
Metro 100XT/3 Eco Wave	30	4.3 - 9.6	3.3 - 9.0	4.1 - 9.1	83.3	B	B	B	200/130	466	+	-	+
Metro 130XT/3 Eco Wave	30	5.1 - 10.8	4.1 - 10.2	5.6 - 10.6	89.6	A	A	A	200/130	463	+	-	+
Lugo 70/3 Eco Wave	32	3.4 - 6.9	2.8 - 6.5	3.2 - 6.3	91.0	A	A	A	150/100	400	-	-	+
Lugo 80/3 Eco Wave	32	3.4 - 6.9	2.8 - 6.5	3.2 - 6.3	91.0	A	A	A	150/100	460	-	-	+
Metro 100XTL Eco Wave	34	4.3 - 9.6	3.3 - 9.0	4.1 - 9.1	83.3	B	B	B	200/130	434	+	-	+
Metro 130XTL Eco Wave	34	5.1 - 10.8	4.1 - 10.2	5.6 - 10.6	89.6	A	A	A	200/130	448	+	-	+
2-SIDED FIRES (closed combustion)													
Maestro 80/2 Eco Wave	36	1.4 - 9.0	1.3 - 8.6	1.3 - 7.7	93.0	A	A	A	200/130	492	+	-	+
Maestro 105/2 Eco Wave	37	2.2 - 9.3	1.8 - 8.7	1.5 - 9.6	87.5	A	A	A	200/130	492	+	-	+
Metro 100XT/2 Eco Wave	38	4.3 - 9.6	3.3 - 9.0	4.1 - 9.1	83.3	B	B	B	200/130	466	+	-	+
Metro 130XT/2 Eco Wave	38	5.1 - 10.8	4.1 - 10.2	5.6 - 10.6	89.6	A	A	A	200/130	466	+	-	+
Lugo 70/2 Eco Wave	40	3.4 - 6.9	2.8 - 6.5	3.2 - 6.3	91.0	A	A	A	150/100	400	-	-	+
Lugo 80/2 Eco Wave	40	3.4 - 6.9	2.8 - 6.5	3.2 - 6.3	91.0	A	A	A	150/100	460	-	-	+
Paco Eco Wave	42	2.6 - 5.4	2.1 - 5.0	-	84.8	B	C	-	150/100	563	+	-	+
FRONT FIRES (closed combustion)													
Excellence 50XT Eco Wave	43	2.3 - 7.9	1.9 - 7.5	-	87.0	B	B	-	150/100	360	+	-	+
Maestro 75 Eco Wave	44	1.3 - 9.0	1.2 - 8.6	1.3 - 7.9	89.0	A	A	A	200/130	400	+	-	+
Maestro 100 Eco Wave	46	2.3 - 10.0	1.9 - 9.3	2.3 - 10.2	92.1	A	A	A	200/130	400	+	-	+
Metro 80XT Eco Wave	48	3.0 - 5.4	2.3 - 5.1	2.8 - 5.7	88.9	A	B	A	150/100	379	+	-	+
Metro 100XT Eco Wave	48	4.3 - 9.6	3.3 - 9.0	4.1 - 9.1	83.3	B	B	B	200/130	380	+	-	+
Metro 130XT Eco Wave	50	5.1 - 10.8	4.1 - 10.2	5.6 - 10.6	89.6	A	A	A	200/130	408	+	-	+
Metro 150XT Eco Wave	50	5.9 - 10.8	4.9 - 10.3	5.3 - 11.1	87.9	A	A	A	200/130	409	+	-	+
Metro 200XT Eco Wave	52	8.9 - 16.7	7.2 - 15.8	-	90.3	A	A	-	200/130	465	+	-	+
Cosmo Eco Wave	53	6.0 - 16.3	4.9 - 15.7	-	89.3	A	A	-	200/130	709	+	-	+
TUNNEL FIRES (closed combustion)													
Maestro 75 Tunnel Eco Wave	54	1.7 - 9.1	1.5 - 8.5	1.9 - 9.5	93.0	A	A	A	200/130	478	+	-	+
Metro 80XT Tunnel Eco Wave	56	3.0 - 5.4	2.3 - 5.1	2.8 - 5.7	88.9	A	B	A	150/100	434	+	-	+
Metro 100XT Tunnel Eco Wave	56	4.3 - 9.6	3.3 - 9.0	4.1 - 9.1	83.3	B	B	B	200/130	419	+	-	+
Metro 130XT Tunnel Eco Wave	58	5.1 - 10.8	4.1 - 10.2	5.6 - 10.6	89.6	A	A	A	200/130	476	+	-	+
Metro 150XT Tunnel Eco Wave	59	5.9 - 10.8	4.9 - 10.3	5.3 - 11.1	87.9	A	A	A	200/130	475	+	-	+
Metro 200XT Tunnel Eco Wave	59	8.9 - 16.7	7.2 - 15.8	-	90.3	A	A	-	200/130	467	+	-	+
Cosmo Tunnel Eco Wave	60	6.0 - 16.3	4.9 - 15.7	-	89.3	A	A	-	200/130	706	+	-	+

	Weight	Eco Wave (p.06)	Easy release door system (p.14)	PowerVent® (p.18)	Clear View glass (p.13)	Interior finish (p.12)					Burner (p.08)	Fire bed (p.10)				
	(kg)				Option	Black	Ceraglass	Natural	Classic stone	Type	Log set brown	Log set white	Stones white	Stones grey	Glass anthracite	
	145	+	-	+	+	+	+	-	-	Dynamic Flame Burner®	+	-	-	-	-	
	145	+	-	+	+	+	+	-	-	Vario Burner	+	-	+	-	+	
	100	+	-	+	+	+	+	-	-	Dynamic Flame Burner®	+	-	-	-	-	
	120	+	+	+	+	+	+	-	-	Dynamic Flame Burner®	+	-	-	-	-	
	145	+	-	+	+	+	+	-	-	Vario Burner	+	-	+	-	+	
	160	+	-	+	+	+	+	-	-	Vario Burner	+	+	+	+	-	
	85	+	-	+	+	+	+	-	-	Vario Burner	+	-	-	-	-	
	96	+	-	+	+	+	+	-	-	Vario Burner	+	-	-	-	-	
	145	+	-	+	+	+	+	-	-	Vario Burner	+	-	+	-	+	
	160	+	-	+	+	+	+	-	-	Vario Burner	+	+	+	+	-	
	100	+	-	+	+	+	+	-	-	Dynamic Flame Burner®	+	-	-	-	-	
	120	+	+	+	+	+	+	-	-	Dynamic Flame Burner®	+	-	-	-	-	
	160	+	-	+	+	+	+	-	-	Vario Burner	+	-	+	-	+	
	160	+	-	+	+	+	+	-	-	Vario Burner	+	+	+	+	-	
	85	+	-	+	+	+	+	-	-	Vario Burner	+	-	-	-	-	
	96	+	-	+	+	+	+	-	-	Vario Burner	+	-	-	-	-	
	70	+	-	+	+	-	+	-	-	Line Burner	+	-	-	-	-	
	120	+	-	+	+	-	+	-	-	Line Burner	+	+	-	-	-	
	80	+	+	+	+	+	+	-	+	Dynamic Flame Burner®	+	-	-	-	-	
	100	+	+	+	+	+	+	-	+	Dynamic Flame Burner®	+	-	-	-	-	
	88	+	-	+	+	+	+	-	-	Vario Burner	+	-	+	-	-	
	145	+	+	+	+	+	+	-	-	Vario Burner	+	-	+	-	+	
	160	+	+	+	+	+	+	-	-	Vario Burner	+	+	+	+	-	
	160	+	+	+	+	-	+	-	-	Vario Burner	+	+	+	+	-	
	265	+	+	+	+	-	+	-	-	Vario Burner	+	-	+	-	+	
	350	+	+	+	+	+	-	-	-	Vario Burner	+	-	-	-	-	
	160	+	+	+	+	+	-	-	-	Dynamic Flame Burner®	+	-	-	-	-	
	96	+	-	+	+	+	-	-	-	Vario Burner	+	-	+	-	-	
	145	+	+	+	+	+	-	-	-	Vario Burner	+	-	+	-	+	
	160	+	+	+	+	+	-	-	-	Vario Burner	+	+	+	+	-	
	160	+	+	+	+	+	-	-	-	Vario Burner	+	+	+	+	-	
	265	+	+	+	+	+	-	-	-	Vario Burner	+	-	+	-	+	
	350	+	+	+	+	+	-	-	-	Vario Burner	+	-	-	-	-	

TECHNICAL SPECIFICATIONS

DRU Gas fires		Net capacity kW (p.06)			Efficiency			Energy efficiency class (p.20)			Duct Ø		Built-in depth		Control hatch (p.86)		Remote control (p.86)	
	Page	Natural gas G20	Natural gas G25.3 (NL)	Propane G31	[%] G20	Natural gas G20	Natural gas G25.3 (NL)	Propane G31	(mm)	(mm)	RCE	RCH						
FREESTANDING FIRES (closed combustion)																		
Circo	62	2.9 - 7.0	2.7 - 6.0	2.8 - 6.2	92.5	A	A	A	150/100	442	-	+	-					
Polo	63	1.6 - 4.1	1.5 - 3.8	1.6 - 3.8	92.6	A	A	A	150/100	400	-	+	-					
Trio	64	2.0 - 4.5	1.8 - 4.2	1.5 - 4.0	85.4	B	B	C	150/100	441	-	+	-					
Diablo Next	65	1.6 - 4.1	1.5 - 3.8	1.6 - 3.8	92.6	A	A	A	150/100	372	-	+	-					
Lugo 70/3 Module Eco Wave	66	3.4 - 6.9	2.8 - 6.5	3.2 - 6.3	91.0	A	A	A	150/100	554	-	-	+					
Passo Eco Wave	67	2.2 - 7.0	2.0 - 6.7	1.9 - 6.5	90.0	A	A	B	150/100	452	-	-	+					

Global by DRU Gas fires		Net capacity kW (p.06)			Efficiency			Energy efficiency class (p.20)			Duct Ø		Built-in depth		Control hatch (p.86)		Remote control (p.86)	
	Page	Natural gas G20	Natural gas G25.3 (NL)	Propane G31	[%] G20	Class G20	Class G25.3 (NL)	Class G31	(mm)	(mm)	RCE	RCH						
FRONT FIRES (open combustion)																		
Global 40 CF	70	1.6 - 3.3	1.3 - 3.1	1.5 - 3.1	81.1	C	C	C	80	291	-	+	-					
Global 55 CF	71	1.9 - 3.9	1.5 - 3.7	1.9 - 4.0	77.7	C	C	C	100	320	-	+	-					
Global 55XT CF	72	1.7 - 4.5	1.7 - 4.2	1.8 - 4.4	74.3	D	D	D	100	320	-	+	-					
Global 70XT CF	72	2.0 - 4.7	2.0 - 4.6	2.9 - 4.8	77.4	C	D	C	100	350	-	+	-					

FREESTANDING FIRES (open combustion)														
Global Beau CF	74	1.6 - 3.3	1.3 - 3.1	1.5 - 3.1	81.1	C	C	C	80	330	-	+	-	

3-SIDED FIRES (closed combustion)														
Global 60 Triple BF	75	2.3 - 6.0	2.1 - 5.4	3.0 - 6.2	91.5	A	A	A	150/100	340	-	+	-	
Global 100 Triple BF	76	2.8 - 7.5	2.6 - 7.1	3.5 - 7.0	94.0	A	A	A	150/100	386	-	+	-	
Global 120 Triple BF	76	2.8 - 7.5	2.6 - 7.1	3.5 - 7.0	94.0	A	A	A	150/100	386	-	+	-	

2-SIDED FIRES (closed combustion)														
Global 60 Corner BF	78	2.3 - 6.0	2.1 - 5.4	3.0 - 6.2	91.5	A	A	A	150/100	325	-	+	-	
Global 100 Corner BF	79	2.8 - 7.5	2.6 - 7.1	3.5 - 7.0	94.0	A	A	A	150/100	386	-	+	-	
Global 120 Corner BF	79	2.8 - 7.5	2.6 - 7.1	3.5 - 7.0	94.0	A	A	A	150/100	386	-	+	-	

FRONT FIRES (closed combustion)														
Global 55XT Cavity BF (UK only)	80	1.8 - 3.2	-	-	77.1	C	-	-	150/100	255	-	+	-	
Global 55XT BF	82	2.8 - 5.0	2.6 - 4.7	3.0 - 5.2	92.0	A	A	A	150/100	340	-	+	-	
Global 70XT BF	82	3.8 - 6.0	3.7 - 5.8	4.0 - 6.2	91.0	A	A	A	150/100	340	-	+	-	
Global 60XT BF	84	2.5 - 6.5	2.3 - 6.0	3.3 - 6.8	91.9	A	A	A	150/100	295	-	+	-	
Global 100 BF	85	2.8 - 7.5	2.6 - 7.1	3.5 - 7.0	94.0	A	A	A	150/100	290	-	+	-	
Global 120 BF	85	2.8 - 7.5	2.6 - 7.1	3.5 - 7.0	94.0	A	A	A	150/100	360	-	+	-	

	Weight	Eco Wave (p.06)	Easy release door system (p.14)	PowerVent® (p.18)	Clear View glass (p.13)	Interior finish (p.12)					Burner (p.08)	Fire bed (p.10)				
(kg)				Option	Black	Ceraglass	Natural	Classic stone	Type	Log set brown	Log set white	Stones white	Stones grey	Glass anthracite		
110	-	-	-	-	+	-	-	-	Line Burner	+	-	-	-	-		
68	-	-	-	-	+	+	-	-	Line Burner	+	-	-	-	-		
80	-	-	-	-	+	-	-	-	Line Burner	+	-	-	-	-		
48	-	-	-	-	+	+	-	-	Line Burner	+	-	-	-	-		
85	+	-	-	-	+	+	-	-	Vario Burner	+	-	-	-	-		
95	+	+	-	-	+	-	-	-	Dynamic Flame Burner®	+	-	-	-	-		

	Weight	Eco Wave (p.06)	Easy release door system (p.14)	PowerVent® (p.18)	Clear View glass (p.13)	Interior finish (p.12)					Burner (p.08)	Fire bed (p.10)				
(kg)				Option	Black	Ceraglass	Natural	Classic stone	Type	Log set brown	Log set white	Stones white	Stones grey	Glass anthracite		
49	-	-	-	-	-	+	-	-	Line Burner	-	+	-	-	-		
43	-	-	-	-	+	+	-	+	Line Burner	+	-	-	-	-		
43	-	-	-	-	+	+	-	+	Line Burner	+	-	-	-	-		
63	-	-	-	-	+	+	+	+	Line Burner	+	-	-	-	-		

60	-	-	-	-	-	+	-	-	Line Burner	-	+	-	-	-		
----	---	---	---	---	---	---	---	---	-------------	---	---	---	---	---	--	--

65	-	-	-	-	+	+	-	-	Line Burner	+	-	+	-	-		
100	-	-	-	-	+	+	-	-	Line Burner	+	-	+	-	+		
120	-	-	-	-	+	+	-	-	Line Burner	+	-	+	-	+		

62	-	-	-	-	+	+	-	-	Line Burner	+	-	+	-	-		
100	-	-	-	-	+	+	-	-	Line Burner	+	-	+	-	+		
120	-	-	-	-	+	+	-	-	Line Burner	+	-	+	-	+		

61	-	-	-	+	-	+	-	-	Global Truflame Burner®	+	-	-	-	-		
90	-	-	-	+	+	+	-	+	Global Truflame Burner®	+	-	-	-	-		
103	-	-	-	+	+	+	-	+	Global Truflame Burner®	+	-	-	-	-		
61	-	-	-	-	+	+	-	-	Line Burner	+	-	+	-	-		
75	-	-	-	-	+	+	-	-	Line Burner	+	-	+	-	+		
120	-	-	-	-	+	+	-	-	Line Burner	+	-	+	-	+		



DRU Verwarming B.V.
 P.O. Box 1021 | 6920 BA Duiven
 Ratio 8 | 6921 RW Duiven
 The Netherlands
 T. +31 (0)26 - 319 5 319
 F. +31 (0)26 - 319 5 348
 www.dru.nl

Drugasar Ltd.
 Deans Road | Swinton
 Manchester | M27 0JH
 United Kingdom
 T. +44 (0)161 - 793 8700
 F. +44 (0)161 - 727 8057
 www.drufire.co.uk

DRU Belgium
 Kontichsesteenweg 69/1
 2630 Aartselaar
 Belgium
 T. +32 (0)3 - 450 7000
 F. +32 (0)3 - 450 7009
 www.drufire.be

Dealer



BY APPOINTMENT OF
 THE COURT OF THE NETHERLANDS

since
1754



www.drufire.com

DRU: Member of the Spartherm-Group

Subject to changes. The colours in this brochure may vary from the actual products. Nothing in this publication may be used without prior written consent from DRU Verwarming B.V.